



INSTRUMENTS

65-2485RK-02
Multi Point Detector
Operator's Manual

Part Number: 71-0237RK

Revision: B

Released: 6/17/20

WARNING

Read and understand this instruction manual before operating detector. Improper use of the detector could result in bodily harm or death.

Periodic calibration and maintenance of the detector is essential for proper operation and correct readings. Please calibrate and maintain this detector regularly! Frequency of calibration depends upon the type of use you have and the sensor types. Typical calibration frequencies for most applications are between 3 and 6 months, but can be required more often or less often based on your usage.

Product Warranty

RKI Instruments, Inc. warrants gas alarm equipment sold by us to be free from defects in materials, workmanship, and performance for a period of one year from date of shipment from RKI Instruments, Inc. Any parts found defective within that period will be repaired or replaced, at our option, free of charge. This warranty does not apply to those items which by their nature are subject to deterioration or consumption in normal service, and which must be cleaned, repaired, or replaced on a routine basis. Examples of such items are:

- a) Absorbent cartridges
- b) Pump diaphragms and valves
- c) Fuses
- d) Batteries
- e) Filter elements

Warranty is voided by abuse including mechanical damage, alteration, rough handling, or repair procedures not in accordance with the operator's manual. This warranty indicates the full extent of our liability, and we are not responsible for removal or replacement costs, local repair costs, transportation costs, or contingent expenses incurred without our prior approval.

THIS WARRANTY IS EXPRESSLY IN LIEU OF ANY AND ALL OTHER WARRANTIES AND REPRESENTATIONS, EXPRESSED OR IMPLIED, AND ALL OTHER OBLIGATIONS OR LIABILITIES ON THE PART OF RKI INSTRUMENTS, INC. INCLUDING BUT NOT LIMITED TO, THE WARRANTY OF MERCHANTABILITY OR FITNESS FOR A PARTICULAR PURPOSE. IN NO EVENT SHALL RKI INSTRUMENTS, INC. BE LIABLE FOR INDIRECT, INCIDENTAL, OR CONSEQUENTIAL LOSS OR DAMAGE OF ANY KIND CONNECTED WITH THE USE OF ITS PRODUCTS OR FAILURE OF ITS PRODUCTS TO FUNCTION OR OPERATE PROPERLY.

This warranty covers instruments and parts sold to users by authorized distributors, dealers, and representatives as appointed by RKI Instruments, Inc.

We do not assume indemnification for any accident or damage caused by the operation of this gas monitor, and our warranty is limited to the replacement of parts or our complete goods.

Table of Contents

Overview	5
Specifications	5
Description	6
Detectors	6
Junction Box	9
Installation	9
Mounting the Multi-Point Detector	9
Wiring the Multi-Point Detector to a Controller	11
Startup	13
Introducing Incoming Power	13
Setting the Zero (Fresh Air) Reading	13
Maintenance	14
Preventive Maintenance	14
Troubleshooting	14
Replacing Components of the Multi-Point Detector	15
Calibration, H₂S and CO Detectors	21
Preparing for Calibration	21
Setting the Zero Reading	22
Setting the Response Reading	22
Returning to Normal Operation	22
Calibration, Oxygen Detector	23
Preparing for Calibration	23
Setting the Fresh Air Reading	24
Setting the Zero Reading	24
Returning to Normal Operation	24
Parts List	25

Overview

This manual describes the 65-2485RK-02 multi point direct connect detector. This manual also describes how to install, start up, maintain, and calibrate the detector when it is used with a gas monitoring controller. A parts list at the end of this manual lists replacement parts and accessories for the detector.

Specifications

WARNING: Do not use this product in a manner not specified in this instruction manual.

Table 1 lists specifications for the multi-point detector.

Table 1: Specifications

Target Gas	O ₂ /H ₂ S/CO *Note: Since the 65-2485RK-02 is a direct connect detector, calibration is done at the controller.
Area Classification	Explosion proof for Class I, Groups B, C, and D
Sampling Method	Diffusion
Detection Range	O ₂ : 0 to 25 %volume H ₂ S: 0 to 100 ppm (parts per million) CO: 0 to 300 ppm (parts per million)
Response Time	90% in 30 seconds
Accuracy	<u>Oxygen:</u> ± 0.5% O ₂ <u>Hydrogen Sulfide:</u> ± 5% of reading or ± 2 ppm H ₂ S (whichever is greater) <u>Carbon Monoxide:</u> ± 5% of reading or ± 5 ppm CO (whichever is greater)
Operating Temperature	23°F to 104°F (-5°C to 40°C)

NOTE: The following symbol on the detector label is a caution to the user to refer to this documentation for installation and operation instructions: 

WARNING: When using the 65-2485RK-02, you must follow the instructions and warnings in this manual to assure proper and safe operation of the 65-2485RK-02 and to minimize the risk of personal injury. Be sure to maintain and periodically calibrate the 65-2485RK-02 as described in this manual.

Description

This section describes the multi-point detector. It consists of the detectors, the terminal strips, the conduit seal, and the junction boxes.

Detectors

This section describes the components of the various detectors that are used with the 65-2485RK-02.

Oxygen Detector

The detector consists of the oxygen sensor, the detector housing body, detector housing cap, and cap gasket.

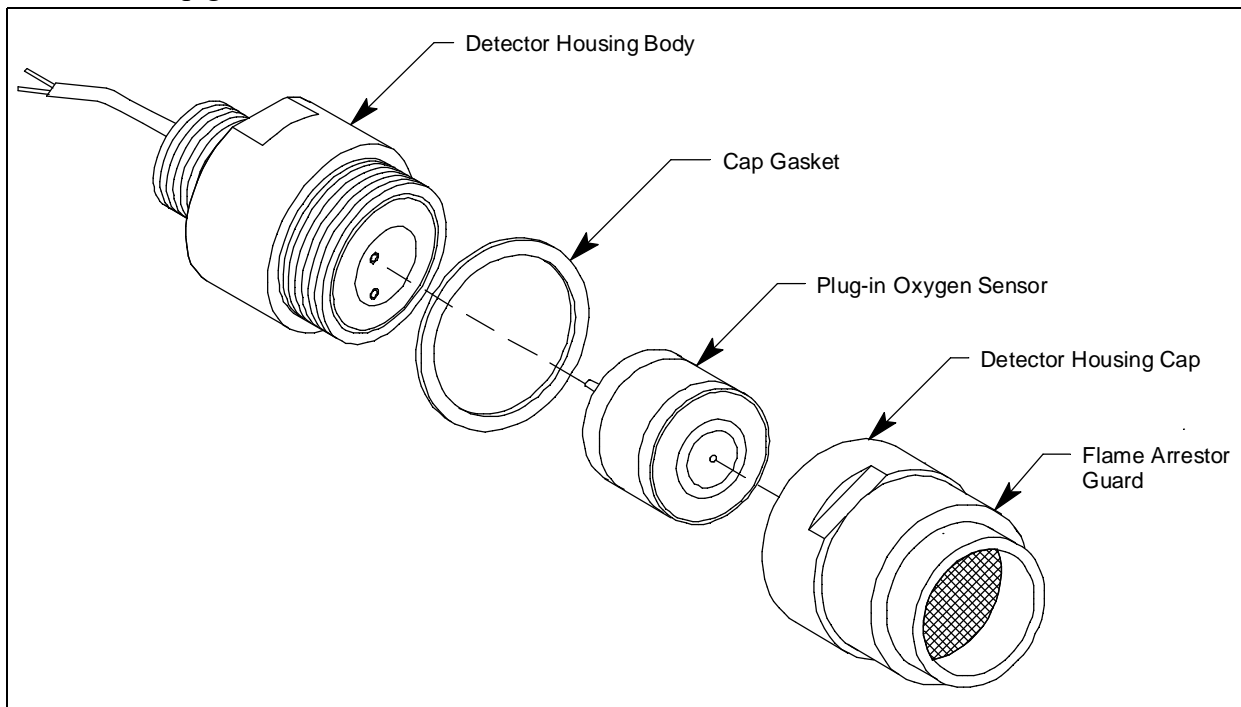

Figure 1: Oxygen Detector Component Location

Detector Housing Body

The detector housing body protects the electronic components within the housing. Use the mounting threads at the top of the housing to screw the oxygen detector into the 3/4 NPT hub on the bottom of the junction box. Two wires extend from the top of the detector housing body. Use these wires to connect the oxygen detector to the terminal block. One of the wires is white and one of the wires is green.

The housing includes two sockets installed on a circuit board. These sockets accept the plug-in sensor's two pins to provide electrical connection for the sensor. The circuit board with the sockets conditions the sensor's signal before the signal reaches the controller.

Housing Cap & Cap Gasket

The housing cap screws onto the detector housing. It retains the plug-in sensor and protects it from damage. A foam gasket is installed inside the housing cap that seals against the sensor face. The housing cap also includes a flame arrestor which contains any sparks that may occur within the detector and a flame arrestor guard which protects the flame arrestor from damage. Unscrew the detector cap to access the plug-in sensor for maintenance or replacement. A cap gasket seals the interface between the housing and cap.

Plug-in Oxygen Sensor

The plug-in sensor is secured in the detector assembly by the housing cap. It has two pins that mate with the sockets in the detector housing body. Through a series of chemical and electrical reactions, the sensor produces an electrical output that corresponds to the detection range of the transmitter.

CO Detector

The detector consists of the CO sensor, charcoal filter with rubber boot, detector housing body, detector housing cap, and cap gasket.

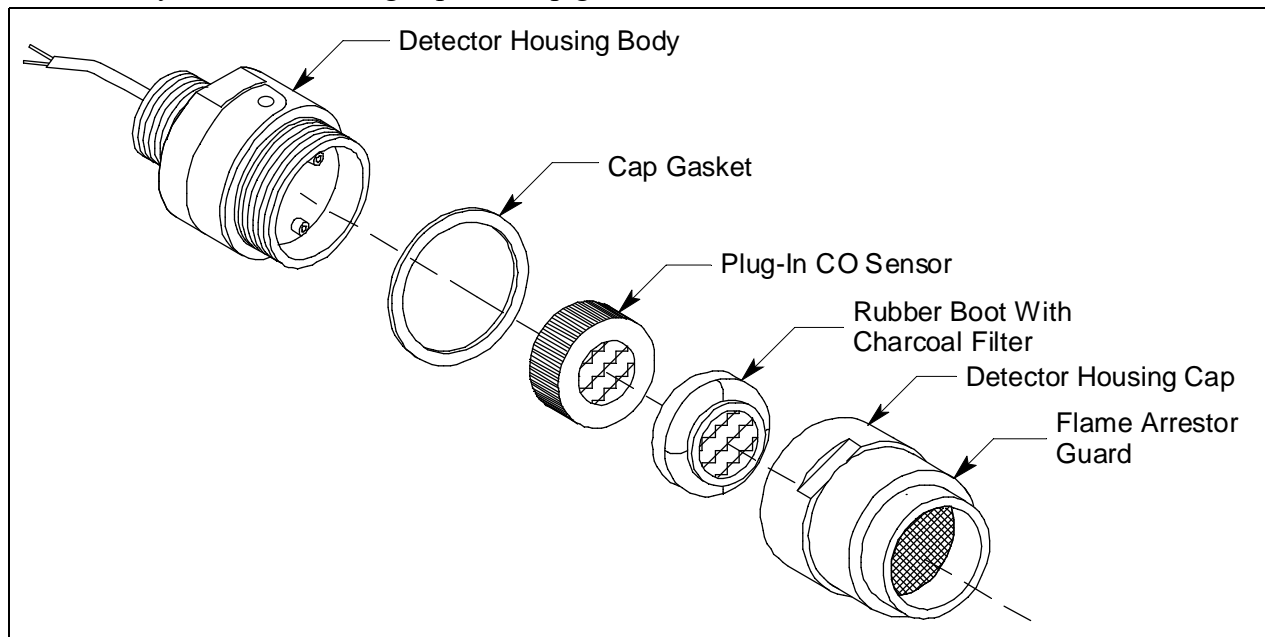

Figure 2: CO Detector Component Location

Detector Housing, Housing Cap, & Cap Gasket

The detector housing body protects the sensing components within the housing. Use the 3/4 NPT mounting threads at the top of the housing to screw the CO detector into the bottom conduit hub of the junction box. Use the removable cap near the bottom of the housing to access the sensor for maintenance or replacement. The cap protects the sensor from damage and includes a flame arrestor which contains any sparks which may occur within the detector housing. A cap gasket seals the interface between the housing and cap. A flame arrestor guard is permanently bonded to the cap.

Two wires extend from the top of the detector housing body. Use these wires to connect the

CO detector to the multi-point detector. The housing includes a four-socket pattern. This socket pattern accepts the sensor's four pins to secure the sensor within the detector housing. A pre-amplifier, located between the sockets and two interconnect wires, conditions the sensor's signal before the signal reaches the controller.

Plug-In Sensor

The sensor is secured within the sensor housing by the housing cap. It has four pins that mate with the sockets in the detector housing body. Through a series of chemical and electrical reactions, the sensor produces an electrical output that corresponds to the detection range of the detector.

Charcoal Filter

The disc-shaped charcoal filter is secured to the face of the CO sensor with a rubber boot. The charcoal filter prevents interference gases (hydrogen sulfide [H₂S] and certain hydrocarbons) from producing false CO readings.

H₂S Detector

The detector consists of the detector housing body, detector housing cap, cap gasket, rubber boot, spacer, and H₂S sensor.

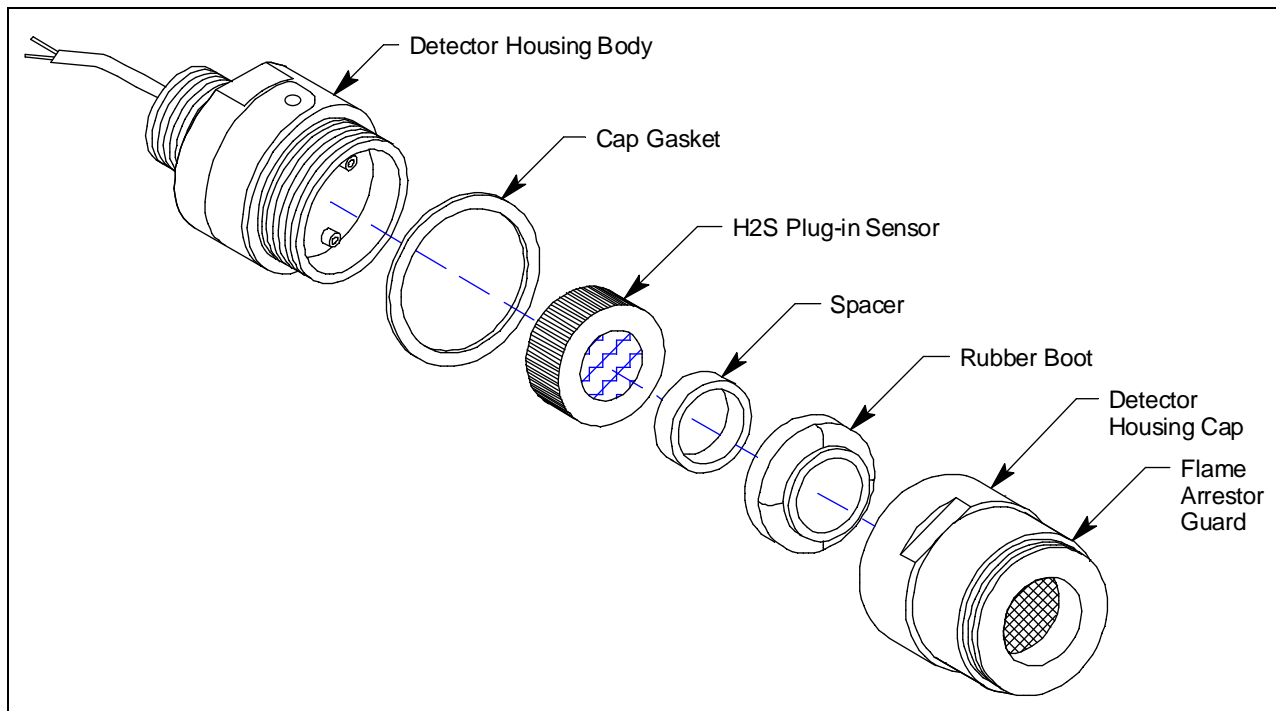

Figure 3: H₂S Detector Component Location

Detector Housing, Housing Cap, & Cap Gasket

The detector housing protects the sensing components within the housing. Use the mounting threads at the top of the housing to screw the H₂S detector into a 3/4 NPT hub. Use the removable cap near the bottom of the housing to access the sensor for maintenance or replacement. The cap protects the sensor from damage and includes a flame arrestor which

contains any sparks which may occur within the detector housing. A cap gasket seals the interface between the housing and cap. A flame arrestor guard is permanently bonded to the cap.

Two wires extend from the top of the detector housing. Use these wires to connect the H₂S detector to the multi-point detector. The housing includes a four-socket pattern. This socket pattern accepts the sensor's four pins to secure the sensor within the detector housing. A pre-amplifier, located between the sockets and two interconnect wires, conditions the sensor's signal before the signal reaches the controller.

Rubber Boot and Spacer

A rubber boot and spacer are installed between the detector housing cap and the sensor. They help ensure that the detector remains plugged into the detector housing body.

Sensor

The sensor is secured within the sensor housing by the detector housing cap. It has four pins that mate with the sockets in the detector housing body. Through a series of chemical and electrical reactions, the sensor produces an electrical output that is proportional to the detection range of the detector.

Junction Box

Use the junction box to install the multi-point detector at a mounting site that is remote from the controller. The junction box protects the terminal strip and wiring connections made to the terminal strip. Use the top 3/4 NPT conduit hub to connect wiring from the terminal strip to the controller. Use the cover on the front of the junction box to access the interior of the junction box. The detectors and terminal strip are factory installed in the junction box.

Installation

This section describes procedures to mount the multi-point detector in the monitoring environment and wire the detector to a controller.

Mounting the Multi-Point Detector

1. Select a mounting site that is representative of the monitoring environment. Consider the following when you select the mounting site.
 - Select a site where the detector is not likely to be bumped or disturbed. Make sure there is sufficient room to perform start-up, maintenance, and calibration procedures.
 - Select a site where the target gases are likely to be found first.

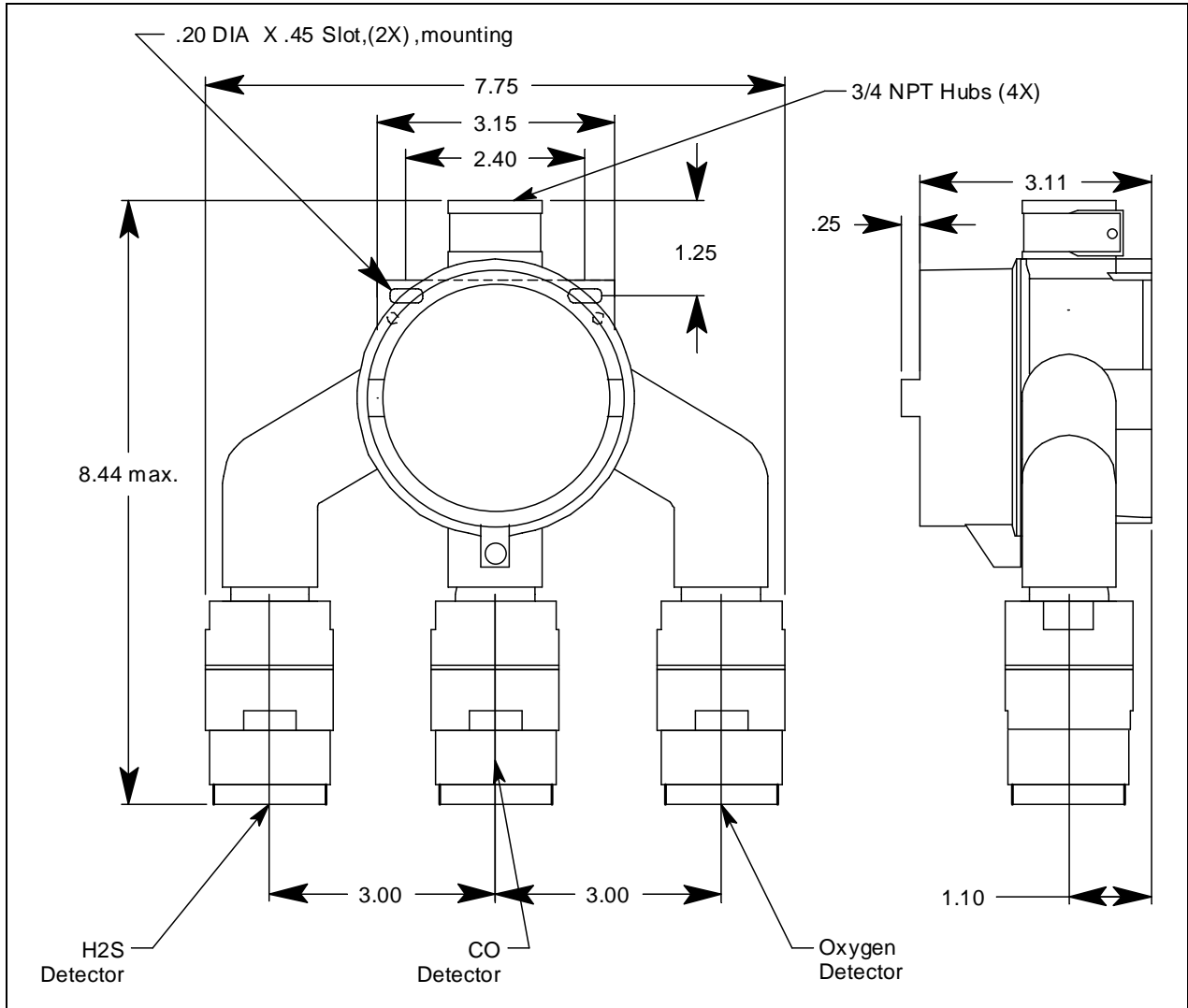

Figure 4: Outline & Mounting Dimensions 65-2485RK-02

- At the mounting site you select, use #10 screws to mount the detector to a vertical surface.

CAUTION: Mount the multi-point detector with the detectors facing down (see Figure 4).

NOTE: If your application does not require a specific mounting site, mount the detector at approximately breathing level.

Wiring the Multi-Point Detector to a Controller

WARNING: *Always verify that the power source is OFF before you make wiring connections.*

1. Turn off the controller.
 2. Turn off or unplug power to the controller.
 3. Remove the junction box cover from the junction box.
-

WARNING: *To maintain the explosion proof classification of the multi-point detector, a conduit seal must be used within 2 inches of the junction box conduit hub used for wiring to the controller.*

4. Guide a six-conductor, shielded cable, or six wires in conduit through the top conduit hub of the junction box. Use appropriate conduit fittings and construction technique for the environmental rating and hazardous location classification of the junction box. The junction box is rated NEMA 4X and classified explosion proof for Class I, Groups B, C, and D.
 5. Connect the wires to the multi-point detector using the terminal block in the junction box.
-

CAUTION: *If using shielded cable, leave the drain wire insulated and disconnected at the multi-point detector. You will connect the opposite end of the cable's drain wire at the controller.*

6. Secure the junction box cover to the junction box.
 7. Route the cable or wires leading from the multi-point detector through one of the conduit hubs at the controller housing. Use appropriate conduit fittings and construction technique for the environmental rating of the controller. RKI controllers are typically rated NEMA 4X.
-

CAUTION: *Do not route power and multi-point detector wiring through the same conduit hub. The power cable may disrupt the transmission of the detector signal to the controller.*

8. Connect the wires to the applicable controller terminal strips. See the controller operator's manual and the controller's detector head specification sheet. Also see Figure 5 for a wiring diagram.

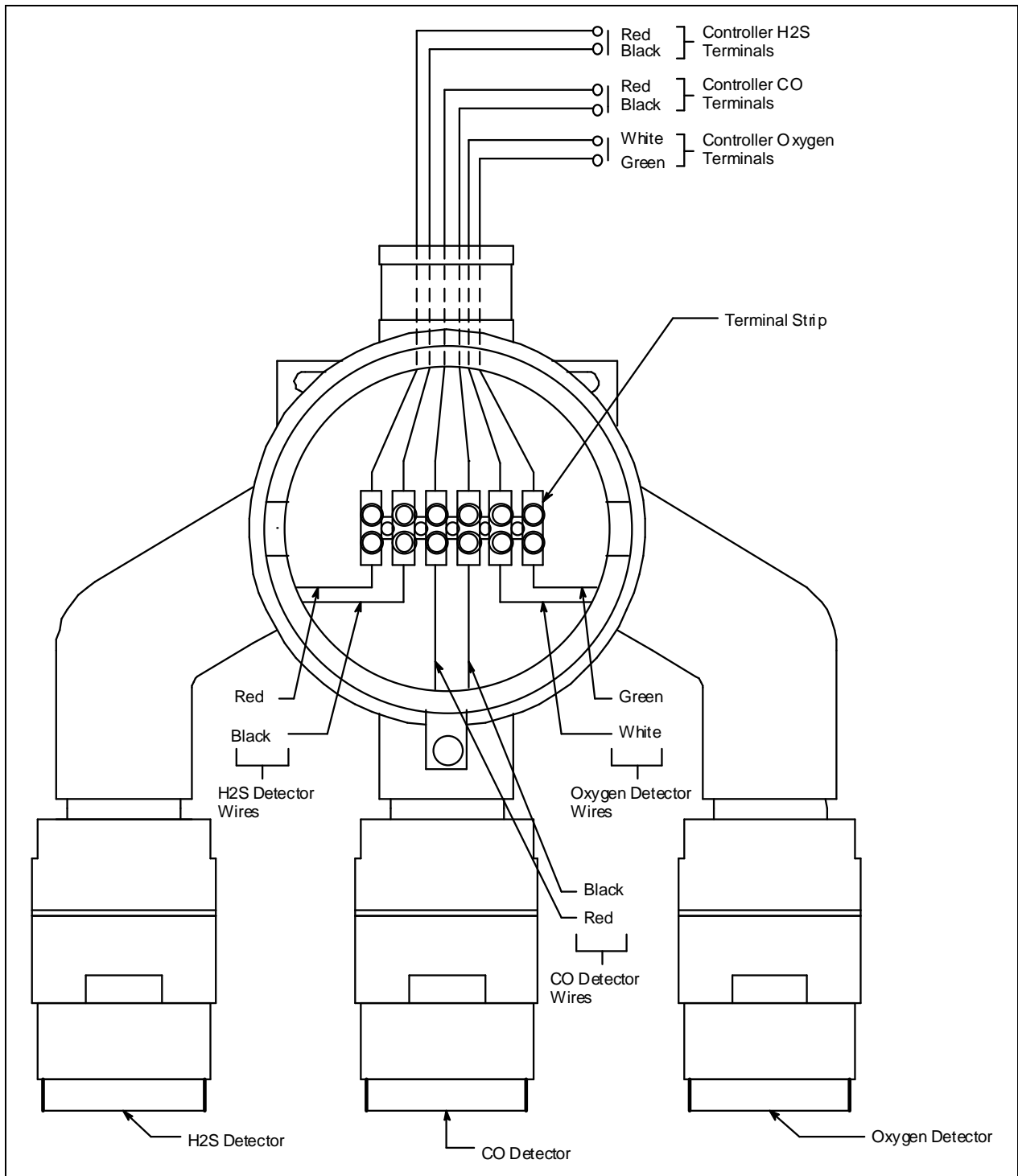

Figure 5: Wiring the 65-2485RK-02 to a Controller

9. Connect the cable's drain wire to an available chassis ground at the controller. RKI controllers typically have a ground stud that can be used to ground the cable's drain wire.

Start Up

This section describes procedures to start up the multi-point detector and place the detector into normal operation.

Introducing Incoming Power

1. Complete the installation procedures described earlier in this manual.
2. Verify that the power wiring to the controller is correct and secure. Refer to the controller operator's manual.
3. Turn on power to the controller.
4. Turn on the controller.
5. Verify that the controller is on and operating properly. Refer to the controller operator's manual.

CAUTION: *Allow the multi-point detector to warm up for 5 minutes before you continue with the next section, "Setting the Zero (Fresh Air) Reading".*

Setting the Zero (Fresh Air) Reading

WARNING: *If the detector installation is explosion proof, do not remove the detector housing cap or junction box cover while the circuits are energized unless the area is determined to be non-hazardous. Keep the detector housing cap and junction box cover tightly closed during operation.*

CAUTION: *If you suspect the presence of a target gas in the monitoring environment, use the calibration kit and a zero air calibration cylinder to introduce "fresh air" to the desired detector and verify an accurate zero setting. See "Calibration, H₂S and CO Detectors" on page 21 or "Calibration, O₂ Detector" on page 23 for instructions to introduce zero air to the desired detector.*

1. Verify that the detector is in a fresh air environment (environment known to be free of toxic gases, and of normal oxygen content, 20.9%).
2. At the controller, verify a reading of:
 - 20.9% for oxygen
 - 0 ppm for CO or H₂S

If the display reading is the appropriate fresh air reading, start up is complete. The detector is in normal operation. If the display reading is not the appropriate fresh air reading, continue with step 3.

3. Perform a zeroing operation at the controller. See the controller operator's manual for directions.

Maintenance

This section describes maintenance procedures. It includes preventive maintenance, troubleshooting, and component replacement procedures.

Preventive Maintenance

This section describes a preventive maintenance schedule to ensure the optimum performance of the multi-point detector. It includes daily and quarterly procedures.

Daily

At the controller, verify a display reading of:

- 20.9% for oxygen
- 0 ppm for CO or H₂S

Investigate significant changes in the display reading.

Quarterly

Calibrate the multi-point detector as described in the Calibration section of this manual.

Troubleshooting

The troubleshooting guide describes symptoms, probable causes, and recommended action for problems you may encounter with the multi-point detector.

NOTE: This troubleshooting guide describes multi-point detector problems only. See the controller operator's manual for problems you may encounter with the controller.

Table 2: Troubleshooting the Multi-Point Detector

Condition	Symptom(s)	Probable Causes	Recommended Action
Fail Condition	Controller indicates a fail condition.	<ul style="list-style-type: none">• The detector wiring is disconnected or misconnected.• The CO, O₂, or H₂S plug-in sensor is not properly plugged into the sockets in the detector housing body.• The detector's zero reading is low enough to cause a fail condition.• The detector is malfunctioning.	<ol style="list-style-type: none">1. Verify that the detector wiring is correct and secure.2. Confirm that the CO, O₂, or H₂S plug-in sensor is installed properly.3. Perform a zero adjustment. A full calibration is recommended.4. If the fail condition continues, replace the CO, O₂, or H₂S plug-in sensor as described later in this section.5. If the fail condition continues, contact RKI for further instruction.

Condition	Symptom(s)	Probable Causes	Recommended Action
Slow or No Response/ Difficult or Unable to Calibrate	<ul style="list-style-type: none"> Unable to accurately set the zero or response reading during calibration. Detector requires frequent calibration. <p><i>Note: Under "normal" circumstances, the transmitter requires calibration once every 3 months. Some applications may require a more frequent calibration schedule.</i></p>	<ul style="list-style-type: none"> The calibration cylinder is low, out-dated, or defective. The flame arrestor in the CO, O₂, or H₂S detector housing cap is wet or clogged with dirt or other particulates. The calibration gas is not an appropriate concentration. The detector is malfunctioning. 	<ol style="list-style-type: none"> Verify that the calibration cylinder contains an adequate supply of a fresh test sample. Check the detector housing cap to determine if the flame arrestor is wet or dirty. Clean if necessary. Verify that the calibration gas concentration is appropriate for each detector. If the calibration/response difficulties continue, replace the CO, O₂, or H₂S plug-in sensor as described later in this section. If the calibration/response difficulties continue, contact RKI for further instruction.
Unexplained Upscale Readings or Alarms	<ul style="list-style-type: none"> Controller indicates a reading that cannot be verified. Alarms occur at the controller that cannot be explained. 	<ul style="list-style-type: none"> Charcoal filter in CO detector is saturated and no longer scrubbing out interfering gases. 	<ol style="list-style-type: none"> Replace charcoal filter in the CO detector. If difficulties continue, contact RKI for further instructions.

Replacing Components of the Multi-Point Detector

This section includes maintenance procedures for the oxygen detector, the CO detector, and the H₂S detector.

Oxygen Detector

This section contains instructions to replace the plug-in oxygen sensor and to replace the entire detector assembly. In most cases it is not necessary to replace the entire detector assembly.

Replacing the Plug-In Oxygen Sensor

CAUTION: *The plug-in sensor contains electrolyte that is an irritant. Do not disassemble the sensor when replacing it with a new one. If electrolyte comes in contact with your skin, wash affected area thoroughly with soap and water.*

- Turn off the controller.
- Turn off or unplug power to the controller.
- Unscrew the detector housing cap from the detector housing body. Make sure not to lose the cap gasket.
- Unplug and remove the oxygen sensor.
- Carefully plug the replacement sensor into the socket pattern that is located in the detector housing.

6. Make sure the cap gasket is in place and screw the detector housing cap back onto the detector housing body.
7. Turn on or plug in power to the controller.
8. Turn on the controller and place into normal operation.

CAUTION: *Allow the replacement sensor to warm up for 5 minutes before you continue with the next step.*

9. Calibrate the detector as described in “Calibration, O₂ Detector” on page 23.

Replacing the Oxygen Detector

NOTE: In most cases, it is only necessary to replace the oxygen sensor.

1. Turn off the controller.
2. Turn off or unplug incoming power to the controller.
3. Remove the junction box cover from the junction box.
4. Disconnect the detector leads from the terminal block in the junction box. Note the position of the color-coded leads as you remove them.
5. Unscrew the detector from the junction box hub.
6. Guide the detector leads of the replacement detector through the junction box hub then screw the mounting threads of the detector into the hub. If necessary for environmental conditions, apply thread sealant or Teflon tape to the hub and/or detector threads to seal them.
7. Connect the detector leads to the terminal block the same way the old detector was wired. See the controller operator’s manual and the controller’s detector head specification sheet for the oxygen detector to verify the connections are correct. Also see Figure 5 for a wiring diagram.
8. Reinstall the junction box cover.
9. Turn on or plug in power to the controller.
10. Turn on the controller.

CAUTION: *Allow the replacement detector to warm up for 5 minutes before you continue with the next step.*

11. Calibrate the replacement detector as described in “Calibration, O₂ Detector” on page 23.

CO Detector

This section includes a procedure to replace the plug-in sensor, one to replace the charcoal filter, and one to replace the entire detector assembly. In most cases it is not necessary to replace the entire detector assembly.

Replacing the Plug-In CO Sensor

CAUTION: *The sensor contains electrolyte which is a dilute acid. Do not disassemble the sensor when replacing it with a new one. If sensor electrolyte comes in contact with your skin, wash affected area thoroughly with soap and water.*

1. Turn off the controller.
2. Turn off or unplug power to the controller.
3. Unscrew the detector housing cap from the detector housing body. Make sure not to lose the cap gasket.
4. Unplug and remove the CO sensor with the boot and charcoal filter attached.
5. Remove the rubber boot and charcoal filter from the old sensor.
6. Remove the replacement sensor from its packaging and remove the wire jumper. This wire jumper is installed on the sensor pins for shipment or storage but must be removed for the sensor to operate properly when installed in a detector.

WARNING: *The CO sensor will not operate properly if the wire jumper is not removed.*

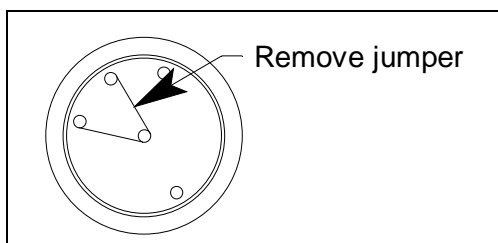

Figure 6: Plug-In Sensor Jumper Removal

7. Install the rubber boot with charcoal filter onto the replacement sensor's face.
8. Carefully plug the replacement sensor into the four-socket pattern that is located in the detector housing.
9. Make sure the cap gasket is in place and screw the detector housing cap back onto the detector housing body.
10. Turn on or plug in power to the controller.
11. Turn on the controller and place into normal operation.

CAUTION: *Allow the replacement sensor to warm up for 5 minutes before you continue with the next step.*

12. Calibrate the replacement sensor as described in “Calibration, H₂S and CO Detectors” on page 21.

Replacing the Charcoal Filter

1. Turn off the controller.
2. Turn off or unplug power to the controller.
3. Unscrew the detector housing cap from the detector housing body.
4. Unplug and remove the CO sensor with the boot and charcoal filter attached.
5. Remove the rubber boot that secures the charcoal filter to the CO sensor.
6. Remove the charcoal filter from the rubber boot.
7. Place the replacement filter in the rubber boot in the same position as the filter you removed in the previous step.
8. Reinstall the rubber boot with charcoal filter to the CO sensor.
9. Carefully plug the replacement sensor into the four-socket pattern that is located in the detector housing.
10. Make sure the cap gasket is in place and screw the detector housing cap back onto the detector housing body.
11. Turn on or plug in power to the controller.
12. Turn on the controller and place into normal operation.

Replacing the CO Detector

NOTE: In most cases, it is only necessary to replace the CO sensor.

1. Turn off the controller.
2. Turn off or unplug power to the controller.
3. Remove the junction box cover from the junction box.
4. Disconnect the detector leads from the terminal block in the junction box. Note the position of the color-coded leads as you remove them.
5. Unscrew the detector from the junction box hub.
6. Guide the detector leads of the replacement detector through the junction box hub then screw the mounting threads of the detector into the hub. If necessary for environmental conditions, apply thread sealant or Teflon tape to the hub and/or detector threads to seal them.
7. Connect the detector leads to the terminal block the same way the old detector was wired. See the controller operator’s manual and the controller’s detector head specification sheet to verify the connections are correct. Also see Figure 5 for a wiring diagram.
8. Reinstall the junction box cover.
9. Turn on or plug in power to the controller.

10. Turn on the controller and place into normal operation.

CAUTION: Allow the replacement detector to warm up for 5 minutes before you continue with the next step.

11. Calibrate the replacement detector as described in the “Calibration, H₂S and CO Detectors” on page 21.

H₂S Detector

This section includes a procedure to replace the H₂S sensor and one to replace the entire detector assembly. In most cases it is not necessary to replace the entire detector assembly.

Replacing the Plug-In H₂S Sensor

CAUTION: The sensor contains electrolyte which is a dilute acid. Do not disassemble the sensor when replacing it with a new one. If sensor electrolyte comes in contact with your skin, wash affected area thoroughly with soap and water.

1. Turn off the controller.
2. Turn off or unplug power to the controller.
3. Unscrew the detector housing cap from the detector housing body. Make sure not to lose the cap gasket.
4. Unplug and remove the H₂S sensor with the rubber boot and spacer attached.
5. Remove the rubber boot and spacer from the old sensor.
6. Remove the replacement sensor from its packaging and remove the wire jumper. This wire jumper is installed on the sensor pins for shipment or storage but must be removed for the sensor to operate properly when installed in a detector.

WARNING: The H₂S sensor will not operate properly if the wire jumper is not removed.

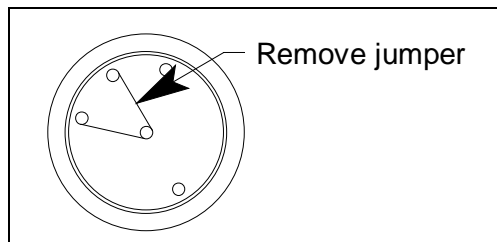

Figure 7: Plug-In Sensor Jumper Removal

7. Install the spacer and rubber boot onto the replacement sensor's face.
8. Carefully plug the replacement sensor into the socket pattern that is located in the detector housing.

9. Make sure the cap gasket is in place and screw the detector housing cap onto the detector housing body.
10. Turn on or plug in power to the controller.
11. Turn on the controller.

CAUTION: *Allow the replacement sensor to warm up for 5 minutes before you continue with the next step.*

12. Calibrate the detector as described in “Calibration, H₂S and CO Detectors” on page 21.

Replacing the H₂S Detector

NOTE: In most cases, it is only necessary to replace the H₂S sensor.

1. Turn off the controller.
2. Turn off or unplug power to the controller.
3. Remove the junction box cover from the junction box.
4. Disconnect the detector leads from the terminal block in the junction box. Note the position of the color-coded leads as you remove them.
5. Unscrew the detector from the junction box hub.
6. Guide the detector leads of the replacement detector through the junction box hub then screw the mounting threads of the detector into the hub. If necessary for environmental conditions, apply thread sealant or Teflon tape to the hub and/or detector threads to seal them.
7. Connect the detector leads to the terminal block the same way the old detector was wired. See the controller operator’s manual and the controller’s detector head specification sheet for the H₂S detector to verify the connections are correct. Also see Figure 5 for a wiring diagram.
8. Reinstall the junction box cover.
9. Turn on or plug in power to the controller.
10. Turn on the controller.

CAUTION: *Allow the replacement detector to warm up for 5 minutes before you continue with the next step.*

11. Calibrate the replacement detector as described in “Calibration, H₂S and CO Detectors” on page 21.

Calibration Frequency

Although there is no particular calibration frequency that is correct for all applications, a calibration frequency of every 3 months is adequate for most multi-point detector applications. Unless experience in a particular application dictates otherwise, RKI Instruments, Inc. recommends a calibration frequency of every 3 months for the multi-point detector.

If an application is not very demanding, for example detection in a clean, temperature controlled environment, and calibration adjustments are minimal at calibration, then a calibration frequency of every 6 months is adequate.

If an application is very demanding, for example if the environment is not well controlled, then more frequent calibration than every 3 months may be necessary.

Calibration, H₂S and CO Detectors

This section describes how to calibrate the H₂S and CO detectors on the multi-point detector. It includes procedures to prepare for calibration, set the zero reading, set the response reading, and return to normal operation. It describes calibration using a calibration kit that includes a calibration cup, calibration gas, sample tubing, and a fixed flow regulator with an on/off knob. RKI Instruments, Inc. recommends using a 0.5 LPM (liters per minute) fixed flow regulator. To properly calibrate the multi-point detector, you must calibrate each connected detector. Perform the following procedure for each connected H₂S or CO detector.

WARNING: The controller is not an active gas monitoring device during the calibration procedure.

Preparing for Calibration

WARNING: Do not remove the junction box cover or detector housing cap while the circuits are energized unless the area is determined to be non-hazardous. Keep the junction box cover and detector housing cap tightly closed during operation.

1. Screw the calibration cup onto the bottom of the detector you wish to calibrate.

NOTE If you can verify that the multi-point detector is in a fresh air environment, you do not need to apply zero air to the detector before adjusting the zero reading.

2. Screw the regulator into the zero air calibration cylinder. Make sure the regulator is off. It is off when the on/off knob is turned all the way clockwise.
3. Use the calibration kit sample tubing to connect the fixed flow regulator to the calibration cup.

4. Put the controller into its calibration program. See the controller operator's manual for instructions to enter the calibration program.

NOTE: RKI controllers have a minimum hold feature for zero adjustment and a peak hold feature for span adjustment. Because of this, the instructions call for turning off the gas to a detector before making adjustments.

Setting the Zero Reading

1. Follow the directions in the controller operator's manual for setting the zero reading.
2. When the instructions call for applying zero air to the detector, turn the regulator's on/off knob counterclockwise to open it. Gas will begin to flow.
3. Allow the gas to flow for two minutes.
4. Turn the regulator's on/off knob clockwise to close it.
5. Set the zero reading according to the controller operator's manual.
6. Unscrew the regulator from the zero air calibration cylinder. Leave the sample tubing connected to the regulator and the calibration cup.

Setting the Response Reading

NOTE: Ensure that you are using an appropriate calibration cylinder for the channel you are calibrating.

1. Follow the directions in the controller operator's manual for setting the response reading (span).
2. For toxic gas cylinders (like H₂S), it is important to vent the regulator while installing it onto the cylinder. Venting the regulator during installation helps prevent air from getting into the cylinder and degrading the gas. When the directions call for exposing the detector to gas, open the regulator by turning the knob counterclockwise and then install it onto the cylinder.
3. Allow gas to flow for 2 minutes before continuing with the directions.
4. Turn the regulator's on/off knob clockwise to close it.
5. Set the response reading according to the controller operator's manual.
6. Unscrew the regulator from the cylinder.

Returning to Normal Operation

1. Unscrew the calibration cup from the detector.

NOTE: For convenience, leave regulator and calibration cup connected by the sample tubing.

2. When the controller display reading falls below the alarm points, return the controller to normal operation.

NOTE: If you do not allow the gas reading to decrease below the alarm points, then unwanted alarms may occur.

3. Verify that the controller display reading decreases and stabilizes at 0 ppm.
4. Store the components of the calibration kit in a safe and convenient place.

Calibration, O₂ Detector

This section describes how to calibrate the oxygen detector on the multi-point detector. It includes procedures to prepare for calibration, set the fresh air reading, set the zero reading, and return to normal operation. It describes calibration using a calibration kit that includes a calibration cup, calibration gas, sample tubing, and a fixed flow regulator with an on/off knob. RKI Instruments, Inc. recommends using a 0.5 LPM (liters per minute) fixed flow regulator. To properly calibrate the multi-point detector, you must calibrate each connected detector. Perform the following procedure for the oxygen detector.

WARNING: *The controller is not an active gas monitoring device during the calibration procedure.*

Preparing for Calibration

WARNING: *Do not remove the junction box cover or detector housing cap while the circuits are energized unless the area is determined to be non-hazardous. Keep the junction box cover and detector housing cap tightly closed during operation.*

1. Screw the calibration cup onto the bottom of the oxygen detector.
2. Screw the regulator into the zero air calibration cylinder. Make sure the regulator is off. It is off when the on/off knob is turned all the way clockwise.

NOTE If you can verify that the multi-point detector is in a fresh air environment, you do not need to apply zero air to the detector before adjusting the fresh air reading.

3. Use the calibration kit sample tubing to connect the fixed flow regulator to the calibration cup.
4. Put the controller into its calibration program. See the controller operator's manual for instructions to enter the calibration program.

NOTE: RKI controllers have a peak hold feature for fresh air adjustment and a minimum hold feature for zero adjustment. Because of this, the instructions call for turning off the gas to a detector before making adjustments.

Setting the Fresh Air Reading

1. Follow the directions in the controller operator's manual for setting the fresh air reading.
2. When the instructions call for applying zero air to the detector, turn the regulator's on/off knob counterclockwise to open it. Gas will begin to flow.
3. Allow the gas to flow for two minutes.
4. Turn the regulator's on/off knob clockwise to close it.
5. Set the fresh air reading according to the controller operator's manual.
6. Unscrew the regulator from the zero air calibration cylinder. Leave the sample tubing connected to the regulator and the calibration cup.

Setting the Zero Reading

1. Screw the regulator into the 100% nitrogen calibration gas cylinder. Make sure the regulator is off. It is off when the on/off knob is turned all the way clockwise.
2. Follow the directions in the controller operator's manual for setting the zero reading.
3. When the directions call for exposing the detector to gas, turn the regulator's on/off knob counterclockwise to open it. Gas will begin to flow.
4. Allow gas to flow for 2 minutes before continuing with the directions.
5. Turn the regulator's on/off knob clockwise to close it.
6. Set the zero reading according to the controller operator's manual.
7. Unscrew the regulator from the cylinder.

Returning to Normal Operation

1. Unscrew the calibration cup from the oxygen detector.

NOTE: For convenience, leave regulator and calibration cup connected by the sample tubing.

2. When the controller display reading rises above the alarm points, return the controller to normal operation.

NOTE: If you do not allow the gas reading to rise above the alarm points, then unwanted alarms may occur.

3. Verify that the controller display reading increases and stabilizes at 20.9% oxygen.
4. Store the components of the calibration kit in a safe and convenient place.

Parts List

Table 5 lists replacement parts and accessories for the multi-point detector.

Table 3: Parts List

Part Number	Description
06-1248RK-03	Calibration kit sample tubing, 3 ft. length
07-0033RK	Detector housing cap gasket (for H ₂ S, O ₂ and CO detectors)
07-0203RK	Rubber retaining boot (for CO and H ₂ S detectors)
14-2101RK	Spacer between H ₂ S sensor and rubber boot
33-7101RK	Charcoal filter disk (for CO detector)
65-1025RK	Oxygen replacement plug-in sensor
65-2428	H ₂ S replacement detector assembly (includes sensor)
65-2438	CO replacement detector assembly (includes sensor)
65-2485RK-02	Multi-point detector assembly, O ₂ /H ₂ S/CO
65-2514RK	Oxygen replacement detector assembly (includes sensor)
71-0237RK	<i>65-2485RK-02 Multi Point Detector Operator's Manual</i> (this document)
81-0064RK-01	Calibration cylinder, 50 ppm CO in air, 34 liter steel
81-0064RK-03	Calibration cylinder, 50 ppm CO in air, 103 liter
81-0076RK	Zero air calibration cylinder, 17 liter
81-0076RK-01	Zero air calibration cylinder, 34 liter steel
81-0076RK-03	Zero air calibration cylinder, 103 liter
81-0078RK-01	Calibration cylinder, 100% nitrogen, 34 liter steel
81-0078RK-03	Calibration cylinder, 100% nitrogen, 103 liter
81-0151RK-02	Calibration cylinder, 25 ppm H ₂ S in nitrogen, 58 liter
81-0151RK-04	Calibration cylinder 25 ppm H ₂ S in nitrogen, 34 liter aluminum
81-0154RK-02	Calibration cylinder, 4-gas mix (CH ₄ / O ₂ / CO/ H ₂ S), 58 liter
81-0154RK-04	Calibration cylinder, 4-gas mix (CH ₄ / O ₂ / CO/ H ₂ S), 34 liter aluminum
81-1050RK	Regulator with gauge and knob, 0.5 LPM, for 17 liter and 34 liter steel calibration cylinders (cylinders with external threads)
81-1051RK	Regulator with gauge and knob, 0.5 LPM, for 34 liter aluminum, 58 liter, and 103 liter calibration cylinders (cylinders with internal threads)
81-1117RK	Calibration cup

Table 3: Parts List

Part Number	Description
ES-1531-CO	CO replacement plug-in sensor
ES-1537-H2S	H ₂ S replacement plug-in sensor