



INSTRUMENTS

35-3010RKA-01 Sample-Draw Detector

Part Number: 71-0211RK

Revision: H

Released: 6/5/17

WARNING

Read and understand this instruction manual before operating detector. Improper use of the detector could result in bodily harm or death.

Periodic calibration and maintenance of the detector is essential for proper operation and correct readings. Please calibrate and maintain this detector regularly! Frequency of calibration depends upon the type of use you have and the sensor types. Typical calibration frequencies for most applications are between 3 and 6 months, but can be required more often or less often based on your usage.

Product Warranty

RKI Instruments, Inc. warrants gas alarm equipment sold by us to be free from defects in materials, workmanship, and performance for a period of one year from date of shipment from RKI Instruments, Inc. Any parts found defective within that period will be repaired or replaced, at our option, free of charge. This warranty does not apply to those items which by their nature are subject to deterioration or consumption in normal service, and which must be cleaned, repaired, or replaced on a routine basis. Examples of such items are:

- a) Absorbent cartridges
- b) Pump diaphragms and valves
- c) Fuses
- d) Batteries
- e) Filter elements

Warranty is voided by abuse including mechanical damage, alteration, rough handling, or repair procedures not in accordance with the operator's manual. This warranty indicates the full extent of our liability, and we are not responsible for removal or replacement costs, local repair costs, transportation costs, or contingent expenses incurred without our prior approval.

THIS WARRANTY IS EXPRESSLY IN LIEU OF ANY AND ALL OTHER WARRANTIES AND REPRESENTATIONS, EXPRESSED OR IMPLIED, AND ALL OTHER OBLIGATIONS OR LIABILITIES ON THE PART OF RKI INSTRUMENTS, INC. INCLUDING BUT NOT LIMITED TO, THE WARRANTY OF MERCHANTABILITY OR FITNESS FOR A PARTICULAR PURPOSE. IN NO EVENT SHALL RKI INSTRUMENTS, INC. BE LIABLE FOR INDIRECT, INCIDENTAL, OR CONSEQUENTIAL LOSS OR DAMAGE OF ANY KIND CONNECTED WITH THE USE OF ITS PRODUCTS OR FAILURE OF ITS PRODUCTS TO FUNCTION OR OPERATE PROPERLY.

This warranty covers instruments and parts sold to users by authorized distributors, dealers, and representatives as appointed by RKI Instruments, Inc.

We do not assume indemnification for any accident or damage caused by the operation of this gas monitor, and our warranty is limited to the replacement of parts or our complete goods.

Table of Contents

Overview	1
Specifications	1
Description	2
Housing	2
Flow System	3
Detection System	5
Installation	10
Mounting the Sample-Draw Detector	10
Connecting the Sample Lines to the Sample-Draw Detector	11
Wiring the Sample-Draw Detector to a Controller	11
Start Up	14
Introducing Incoming Power	14
Setting the Zero Reading	14
Operation	15
Normal Operation	15
Low Flow Alarm	15
Maintenance	15
Preventive Maintenance	15
Troubleshooting	16
Replacing Components of the Sample-Draw Detector	18
Adjusting the Low Flow Setting	19
Calibration Frequency	20
Calibration, LEL Detector	20
Preparing for Calibration	20
Setting the Zero Reading	21
Setting the Response Reading	21
Returning to Normal Operation	21
Calibration, Oxygen Detector	22
Preparing for Calibration	22
Setting the Zero Reading	23
Setting the Fresh Air Reading	23
Returning to Normal Operation	23
Calibration, CO and H₂S Detectors	23
Preparing for Calibration	23
Setting the Zero Reading	24
Setting the Response Reading	24
Returning to Normal Operation	25
Parts List	25

Overview

This manual describes the 35-3010RKA-01 sample-draw detector. This manual also describes how to install, start up, maintain, and calibrate the detector. A parts list at the end of this manual lists replacement parts and accessories for the sample-draw detector.

Specifications

Table 1 lists specifications for the 35-3010RKA-01.

Table 1: Specifications

Target Gases & Detection Ranges	Combustible Gas: 0 - 100% LEL Oxygen: 0-25% volume Carbon Monoxide (CO): 0 - 300 ppm Hydrogen Sulfide (H ₂ S): 0 - 100 ppm
Input Power	24 VDC
Current Draw	275 mA
Output Signals	4-20 mA each channel
Construction (housing)	Fiberglass/polyester (NEMA 4X)
Dimensions	15.44 in. H x 12.55 in. W x 8.31 in. D
Weight	14 lbs.
Sampling Method	Sample-draw
Sample Flow	1.2 SCFH (nominal)
Response Time	90% in 30 seconds
Accuracy	<u>Combustible Gas:</u> ± 5% of reading or ± 2% LEL (whichever is greater) <u>Oxygen:</u> ± 0.5% O ₂ <u>Hydrogen Sulfide (H₂S):</u> ± 5% of reading or ± 2 ppm H ₂ S (whichever is greater) <u>Carbon Monoxide (CO):</u> ± 5% of reading or ± 5 ppm CO (whichever is greater)

WARNING: *When using the 35-3010RKA-01, you must follow the instructions and warnings in this manual to assure proper and safe operation of the 35-3010RKA-01 and to minimize the risk of personal injury. Be sure to maintain and periodically calibrate the 35-3010RKA-01 as described in this manual.*

Description

This section describes the components of the 35-3010RKA-01 sample-draw detector. The sample-draw detector consists of the housing, flow system, and detection system.

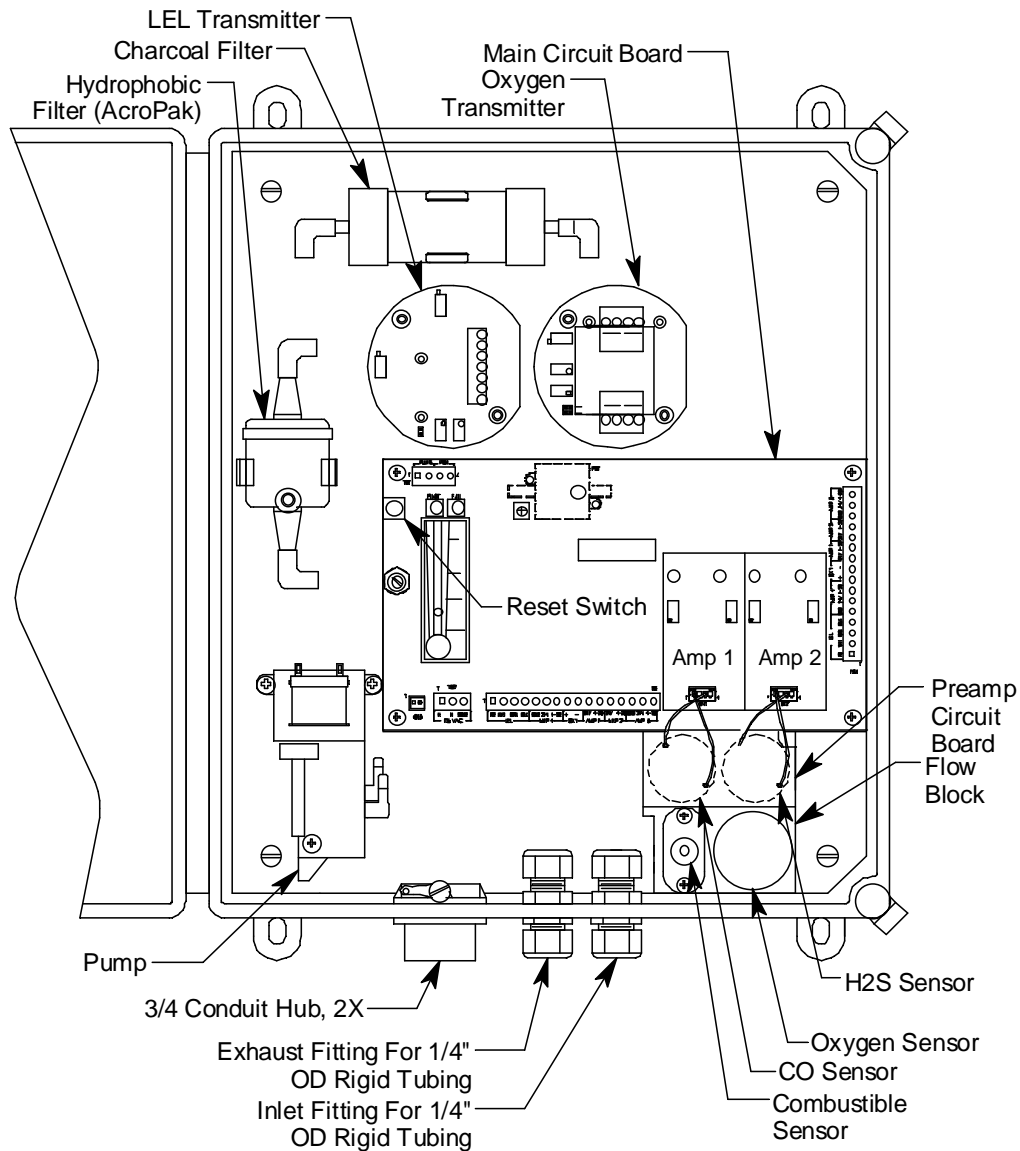

Figure 1: Sample-Draw Detector Component Location

Housing

The sample-draw detector's fiberglass housing is weather- and corrosion-resistant. It is suitable for installation where general purpose equipment is in use. The housing door is hinged on the left side and is secured by two latches on the right side.

Four mounting feet are attached to the back of the housing (one at each corner). Use the mounting feet to install the housing to a vertical surface. Use the two conduit hubs on the bottom of the housing to make wiring connections.

An aluminum subpanel is mounted to the interior of the housing. The sample-draw detector's internal components are mounted to the subpanel.

Flow System

The sample-draw detector's flow system consists of the INLET fitting, hydrophobic filter, charcoal filter, pump, flowmeter, bypass valve, status lights, pressure switch, flow block, and EXHAUST fitting (see Figure 1). Figure 2 illustrates how the gas sample moves through the flow system.

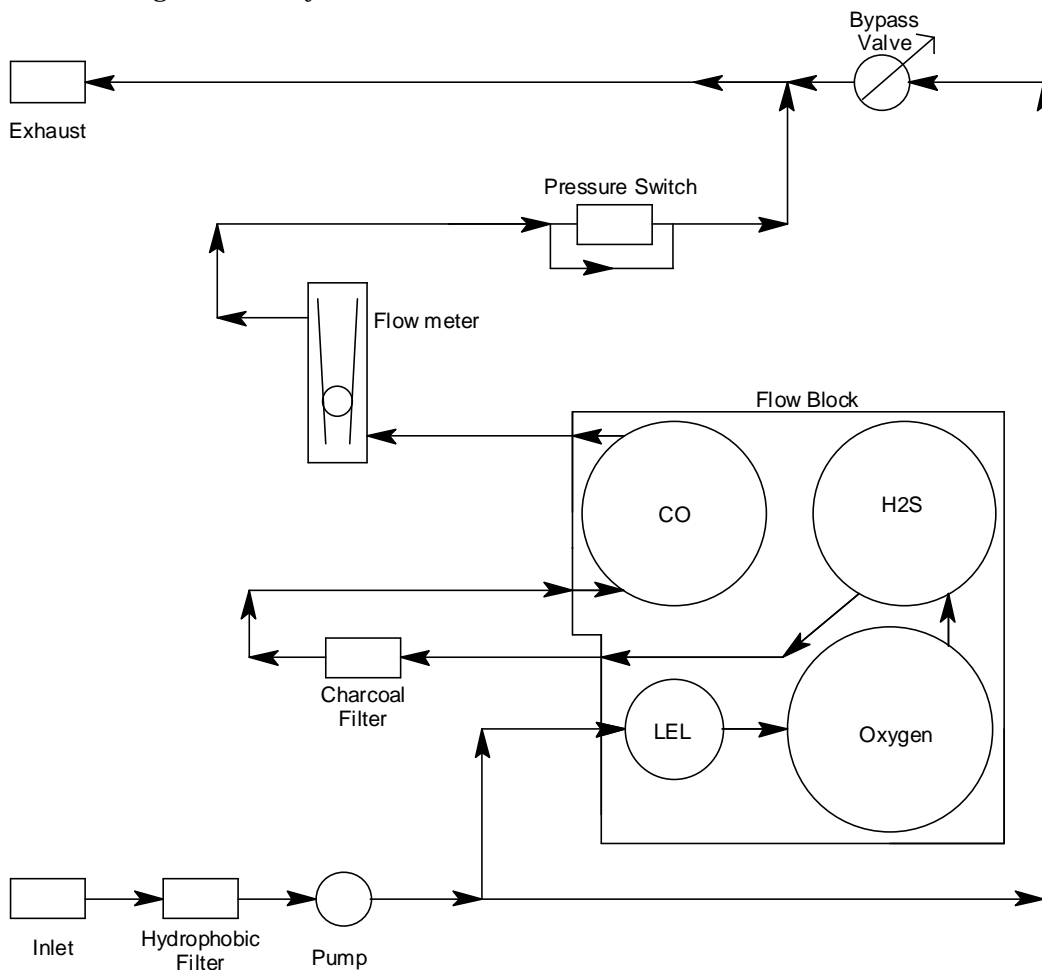

Figure 2: Sample-Draw Detector Flow Diagram

INLET Fitting

The INLET fitting on the bottom of the housing allows the gas sample to enter the sample-draw detector. The INLET fitting accepts 1/4 in. rigid tubing. See "Installation" on page 10 for instructions to connect tubing to the INLET fitting.

Hydrophobic Filter

The hydrophobic filter is to the left of the main circuit board. It is held in place by a metal clip. It prevents water and other liquids from contaminating the flow system. Replace the filter when it appears dirty, discolored, or clogged. If a liquid other than water is drawn into the filter, replace the filter as soon as possible.

Charcoal Filter

The charcoal filter is located above the LEL transmitter. It is held in place by a metal clip. The charcoal filter is placed after the H₂S sensor and before the CO sensor in the flow system. It scrubs out interfering gases which may cause the CO sensor to respond, such as H₂S or certain hydrocarbons. Replace the charcoal filter when false high CO readings are noticed, especially in the presence of H₂S.

Pump

The pump is located to the left of the main circuit board near the bottom left of the sample-draw detector. The pump pulls the gas sample into the sample-draw detector. The pump operates on 24 VAC, which is generated from the 24 VDC supplied to the sample draw detector.

Flowmeter

The flowmeter is attached to the main circuit board near the top left corner (see Figure 1). A ball in the flowmeter column indicates the flow rate of the sample-draw detector. The flowmeter measures the flow in the range 0.2 to 2.0 SCFH (Standard Cubic Feet per Hour). Although the sample-draw detector will operate down to a flow of 0.6 SCFH, the optimum flow rate is 1.2 SCFH.

Bypass Valve

The bypass valve is to the left of the flowmeter. The bypass valve adjusts the flow rate to the sensor. Use a flat-blade screwdriver to adjust the bypass valve.

NOTE: The bypass valve allows fine adjustments of the flow rate. For a wider range of adjustment, use the flow adjust potentiometer (see Figure 1).

Status Lights

Two status lights are above the flowmeter.

Pilot Light

The green Pilot light is on when the sample-draw detector is receiving power.

Fail Light

The red Fail light is on when the sample flow rate is below the low flow level.

NOTE: The factory set low flow level is 0.6 SCFH (± 0.2). See "Adjusting the Low Flow Setting" on page 19 for instructions to adjust this setting.

Pressure Switch

The pressure switch is mounted to the opposite side of the main circuit board. The pressure switch monitors the flow rate of the incoming gas sample.

If the flow rate falls below the preset low flow level, the pressure switch causes the fail relay to interrupt the signal in the 4-20 mA line for the H₂S and CO channels. This causes a downscale reading at the monitor on these channels. The low flow level is factory-set at 0.6 SCFH (± 0.2 SCFH).

NOTE: There is no low flow indication for the LEL or oxygen channels.

Flow Block

The flow block is located in the lower right corner of the sample-draw detector. All the sensors are installed in the flow block. The flow block routes the sampled air to each sensor.

EXHAUST Fitting

The EXHAUST fitting on the bottom of the housing allows the gas sample to exit the sample-draw detector. The EXHAUST fitting accepts 1/4 in. rigid tubing. See “Installation” on page 10 to connect tubing to the EXHAUST fitting.

Detection System

The detection system consists of the gas sensors, LEL and oxygen transmitters, preamp circuit board, and the main circuit board.

Combustible Gas Sensor

The combustible gas sensor is installed in the lower left of the flow block. The combustible gas sensor includes the sensing elements, flame arrestor, connector, and sensor leads.

Sensing Elements

Two sensing elements are protected within the sensor assembly. Through a series of thermal and electronic reactions, these elements produce an output that is proportional to the detection range of the sample draw detector. The LEL transmitter converts the output to a 4 - 20 mA signal which can be used by a recording or monitoring device.

The porous flame arrestor allows the gas sample to enter the sensor assembly and contact the sensing element. The flame arrestor also contains sparks within the sensor.

Connector

The top of the sensor includes five pins that plug into the socket connector. This connector allows you to replace the sensor without disconnecting the wiring. The sensor leads are soldered to the connector.

Sensor Leads

Four color-coded leads extend from the connector. The leads allow you to connect the combustible gas sensor to the main circuit board.

Oxygen Sensor

The oxygen sensor is installed in the lower right of the flow block. The oxygen sensor includes the oxygen cell, connector, and sensor leads.

Oxygen Cell

The oxygen cell is protected within the sensor assembly. Through a series of chemical and electronic reactions, the cell produces a millivolt output that is proportional to the detection range of the sample-draw detector. The oxygen transmitter converts the output to a 4 - 20 mA signal which can be used by a recording or monitoring device.

Connector

The cable that extends from the sensor terminates in a socket that plugs into a matching 7-pin male connector. The socket and connector allow you to replace the sensor without disconnecting the wiring. The sensor leads are soldered to the male connector.

Sensor Leads

Two color-coded leads extend from the connector. The leads allow you to connect the oxygen sensor to the main circuit board.

Carbon Monoxide Sensor

The carbon monoxide gas sensor is installed in the upper left side of the flow block. It has 4 pins which mate with sockets in the preamp circuit board.

Hydrogen Sulfide Gas Sensor

The hydrogen sulfide gas sensor is installed in the upper right side of the flow block. It has 4 pins which mate with sockets in the preamp circuit board.

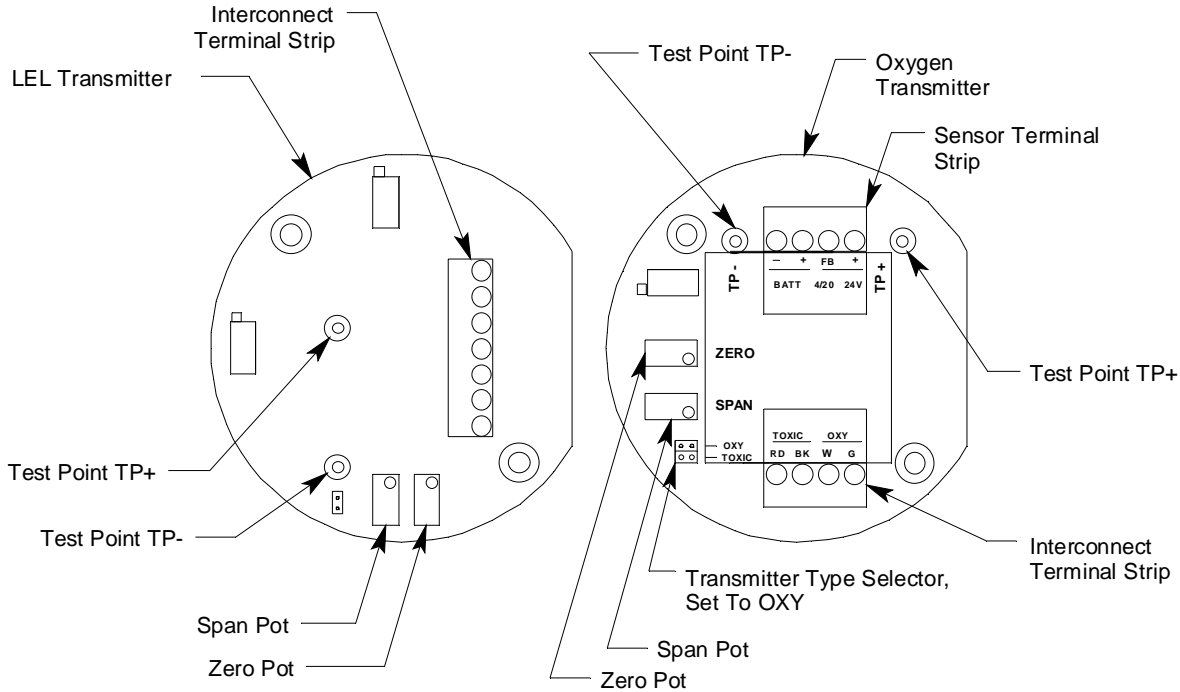

Figure 3: LEL & Oxygen Transmitters

LEL Transmitter

The LEL transmitter is mounted to the left of the oxygen transmitter and above the main circuit board. It consists of the span pot, zero pot, one internally wired terminal strip, and the test points.

Span/Zero Pots

The span and zero pots are located at the bottom edge of the transmitter and are used for calibration. Use the span pot to make adjustments to gas response readings and the zero pot to make adjustments to the zero reading

Transmitter Interconnect Terminal Strip

The transmitter interconnect terminal strip is the seven-point terminal strip near the right edge of the transmitter. The transmitter is factory wired to the sensor and main circuit board.

Test Points

The test points are located on the left side of the transmitter and are labeled TP+ and TP-. A 100 mV - 500 mV output is available at these test points for use during calibration.

Oxygen Transmitter

The oxygen transmitter is mounted to the right of the LEL transmitter and above the main circuit board. The amplifier includes the amplifier type selector, two internally wired

terminal strips, span pot, zero pot, and test points.

Transmitter Type Selector

The transmitter type selector is near the bottom left corner of the amplifier. It is to the left of the detector terminal strip and below the span pot.

The transmitter included with the sample-draw detector is designed for use with RKI's oxygen and toxic gas sensors. The transmitter type selector determines for which sensor the amplifier is intended. For oxygen transmitters, a jumper block is installed over the **OXY** selector.

Detector Terminal Strip

The detector terminal strip is the four-point terminal strip near the bottom edge of the transmitter. It is factory wired to the transmitter.

Interconnect Terminal Strip

The interconnect terminal strip is the four-point terminal strip near the top edge of the transmitter. It is factory wired to the main circuit board.

Span/Zero Pots

The span and zero pots are located on the left side of the transmitter and are used for calibration. Use the span pot to make adjustments to gas response readings and the zero pot to make adjustments to the zero reading

Test Points

The test points are located on the top of the transmitter on either side of the transmitter interconnect terminal strip. They are labeled **TP+** and **TP-**. A 100 mV - 500 mV output is available at these test points for use during calibration.

Preamp Circuit Board

The preamp circuit is used to connect the CO and H₂S sensors to the main circuit board and to secure the sensors in the flow block. Two cables mate to the main circuit board: the one on the left is for the CO sensor signal and the one of the right is for the H₂S sensor signal.

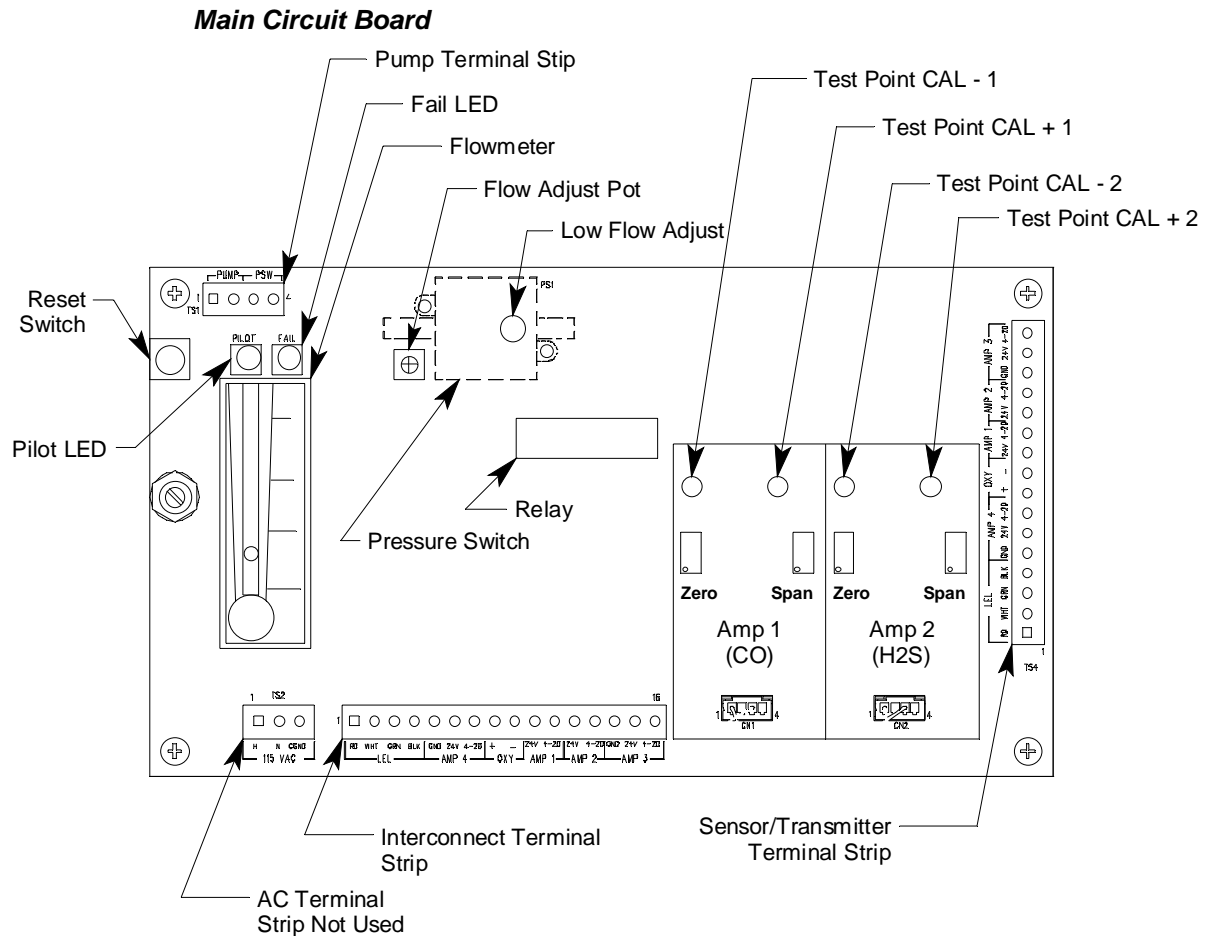

Figure 4: Main Circuit Board

The main circuit board includes the interconnect terminal strip, sensor/transmitter terminal strip, amp 1 circuit, amp 2 circuit, pump terminal strip, relay, and reset switch (see Figure 4).

NOTE: The flowmeter and status lights are mounted to the main circuit board but are considered part of the flow system.

Interconnect Terminal Strip

The interconnect terminal strip is the sixteen-point terminal strip near the bottom edge of the main circuit board. Use the interconnect terminal strip to connect the sample-draw detector to power and an external device.

Sensor/Transmitter Terminal Strip

The sensor/transmitter terminal strip is the sixteen-point terminal strip near the right edge of the circuit board. Use the transmitter terminal strip to connect sensors or transmitters to the main circuit board.

NOTE: The sensors and transmitters are factory wired to the sensor/transmitter terminal strip. See “Wiring the Sample-Draw Detector” on page 11 for all wiring procedures related to the sample-draw detector.

Amp 1 and Amp 2 Circuits

These circuits are located to the left of the sensor/transmitter terminal strip. They each include test points, a zero pot, and a span pot. Amp 1 is on the left and is for the CO channel. Amp 2 is on the right and is for the H₂S channel.

The zero and span pots are used during calibration. Use the span pot to make adjustments to gas response readings and the zero pot to make adjustments to the zero reading.

The test points are labeled **CAL-1** and **CAL+1** for the CO channel and **CAL-2** and **CAL+2** for the H₂S channel. A 100 mV - 500 mV output is available at each set of test points for use during calibration.

Pump Terminal Strip

The pump terminal strip is the four-point terminal in the top left corner of the circuit board. Use the pump terminal strip to connect the pump and pressure switch to the main circuit board.

NOTE: The pump and pressure switch are factory-wired to the circuit board. See “Wiring the Sample-Draw Detector” on page 11 for all wiring procedures related to the sample-draw detector.

Relay

The relay is approximately in the middle of the circuit board. The relay is a four pole, double-throw (4PDT) relay and is rated for 2 amps at 25 VDC (resistive). If the pressure switch senses a low flow condition, the relay interrupts the 4-20 mA signal from the H₂S and CO channels which will cause a downscale reading at the controller or recording device.

NOTE: There is no flow fail indication for the LEL and oxygen channels on the 35-3010RKA-01 Sample Draw Adapter.

Reset Switch

A small reset button is located in approximately the upper left corner of the main PCB. When a low flow condition occurs, the pump will be shut off. To reset the low flow condition and start the pump again, press and hold the reset switch for about 2 seconds, then release.

Installation

This section describes procedures to mount the sample-draw gas detector in the monitoring environment and wire the sample-draw detector to power and an external device.

Mounting the Sample-Draw Detector

1. Select the mounting site. Consider the following when you select the mounting site.
 - Is there enough room to open the housing door and make wiring connections at the bottom of the housing and tubing connections at the right of the housing?
 - Make sure there is sufficient room to perform start-up, maintenance, and calibration procedures.

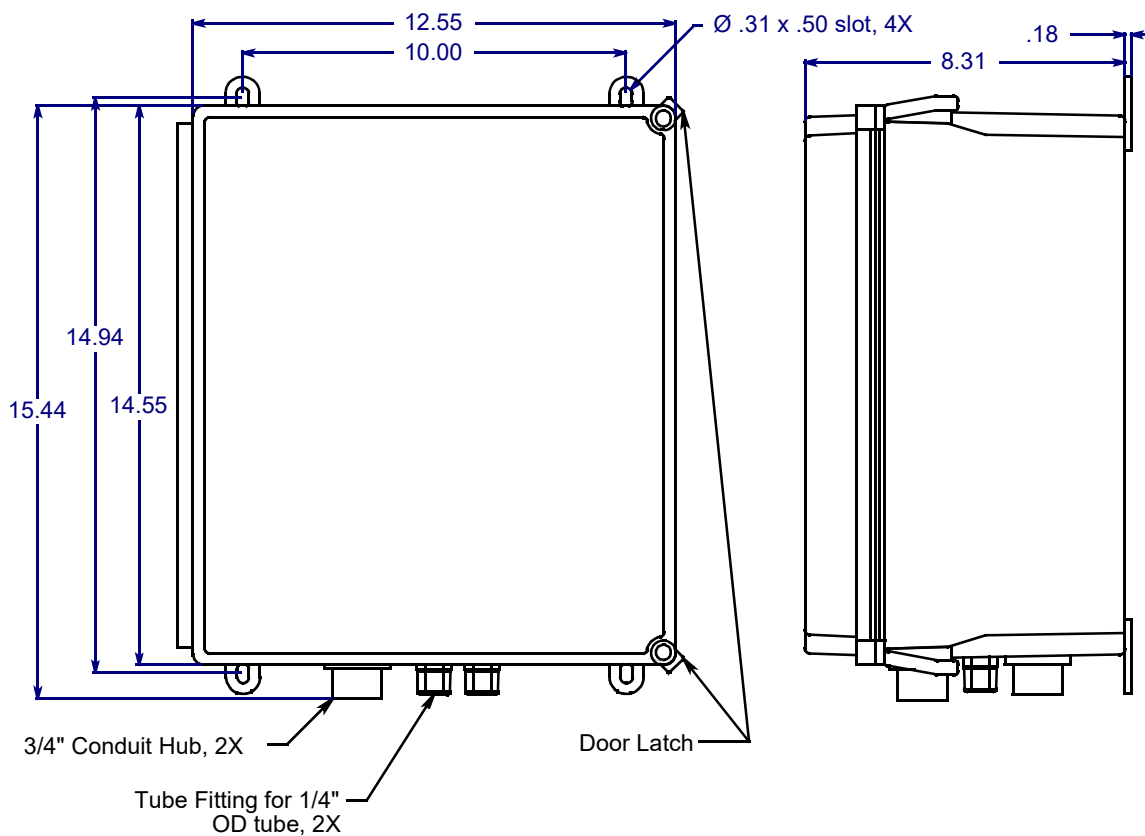

Figure 5: Mounting the Sample-Draw Detector

2. Close and latch the housing door.

NOTE: The sample-draw detector is shipped with the mounting feet “tucked under” the housing to protect the mounting feet during shipment.

3. Slightly loosen the screw that secures one of the mounting feet to the housing, then rotate the mounting foot 180 degrees (see Figure 3).
4. Tighten the screw that secures the mounting foot to the housing.

5. Repeat steps 3 and 4 for the remaining three mounting feet.
6. Position the sample-draw housing on a vertical surface at eye level (4 1/2 to 5 feet from the floor).
7. Insert 1/4 in. or 5/16 in. screws through the slots in the mounting feet to secure the housing to the mounting surface.

Connecting the Sample Lines to the Sample-Draw Detector

1. Attach 1/4 in. O.D. rigid polypropylene or rigid Teflon sample tubing to the INLET fitting.

CAUTION: *If you use **flexible** sample tubing (polyurethane is acceptable), use an appropriate insert to seal the connection between the tubing and the INLET fitting.*

2. Place the opposite end of the tubing at the sampling area.

CAUTION: *Avoid loops or slumps in the incoming sample line. To reduce response time, keep the incoming sample line as short as possible.*

3. Attach rigid sample tubing to the EXHAUST fitting.
4. Route the opposite end of the tubing to an open area where the sample can safely disperse.

Wiring the Sample-Draw Detector

WARNING: *Always verify that the power source is OFF before you make wiring connections.*

1. Turn off the controller.
2. Turn off or unplug incoming power to the controller.
3. Unlatch and open the housing door of the sample-draw detector.
4. Guide a ten-conductor 18 gauge, shielded cable or ten 18 gauge wires in conduit through one of the conduit hubs at the bottom of the sample-draw housing. If necessary, use both hubs to bring the wires in making sure that all the wires for a particular channel go through the same hub.
5. Connect the cable to the sample-draw detector's interconnect terminal strip as shown in Figure 6.
6. Close and latch the housing door of the sample-draw detector.

CAUTION: *Leave the cable shield drain wire insulated and disconnected at the sample-draw detector. You will connect the opposite end of the drain wire at the device.*

7. Route the cable or wires in conduit leading from the sample-draw detector to the monitoring device and power.
8. Connect the drain wire to an available chassis ground at the device end. RKI controllers typically have a ground stud that can be used to ground the cable's drain wire.

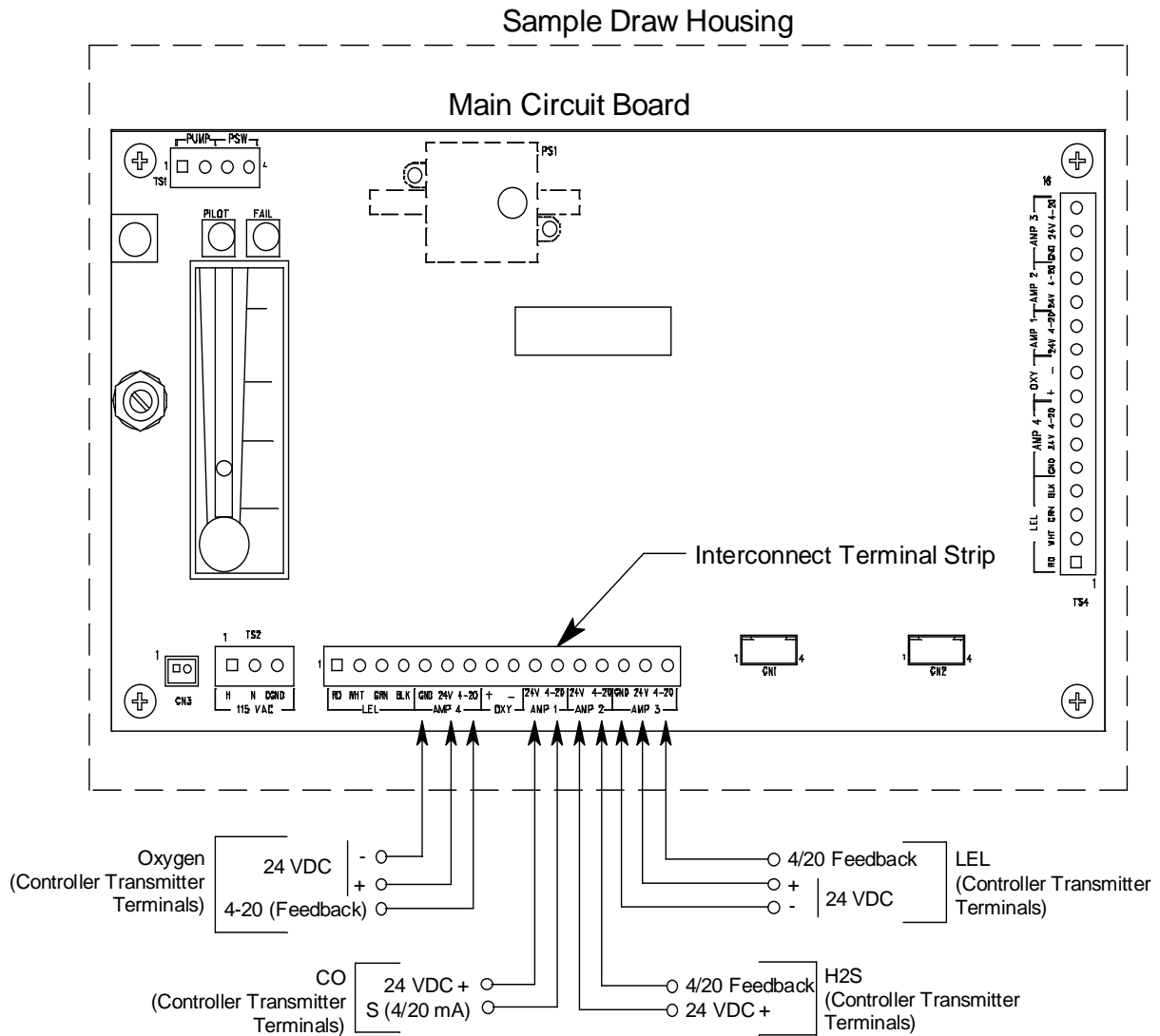

Figure 6: External (Field) Wiring, Sample-Draw Detector

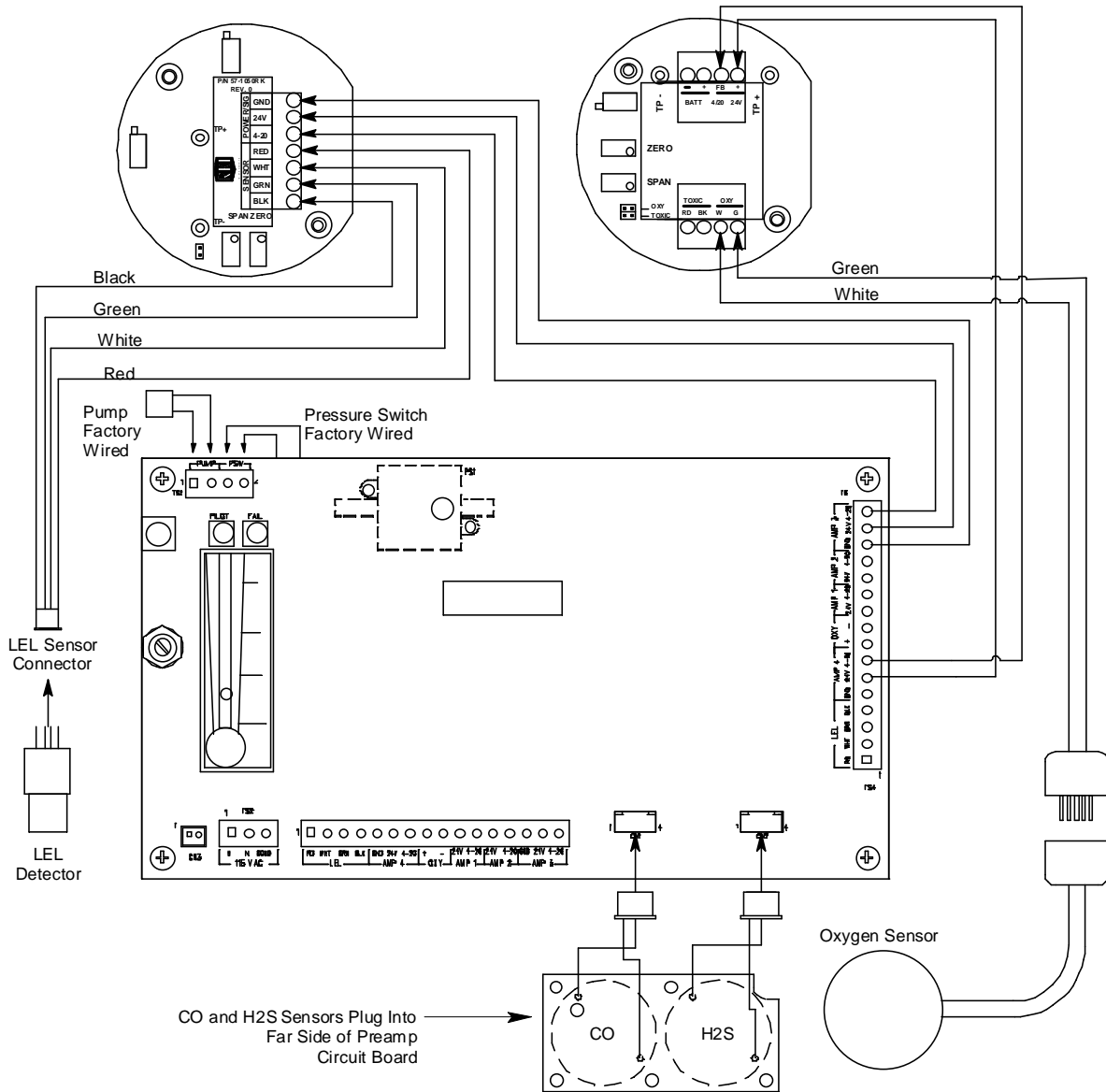

Figure 9: Internal (Factory) Wiring, Sample-Draw Detector

Start Up

This section describes procedures to start up the sample-draw detector and place the sample-draw detector into normal operation.

Introducing Incoming Power

1. Complete the installation procedures described earlier in this manual.
2. Verify that the power wiring to the controller is correct and secure. See the controller operator's manual.
3. Turn on or plug in the incoming power at the controller, then turn on the controller.
4. Verify that the controller is on and operating properly.
5. Verify that the Pilot light is on at the sample draw detector.
6. Verify that the flowmeter indicates a flow rate of approximately 1.2 SCFH. If necessary, use the bypass valve or flow adjust potentiometer to adjust the flow rate.

NOTE: The following step tests for leaks in the sample line. This test may cause a low flow condition at the sample-draw detector.

7. Verify that the incoming sample line is not leaking. To test the sample line, plug the open end of the sample line with your thumb. If the flowmeter ball drops to the bottom of the flowmeter, the incoming sample line is not leaking.
8. Remove your thumb from the sample line, press the pump reset switch, and verify the flowmeter returns to a normal flow rate.

Setting the Zero Reading

CAUTION: *If you suspect the presence of combustible gas, hydrogen sulfide, carbon monoxide, or an abnormal oxygen condition (not 20.9%) in the monitoring environment, use the calibration kit and the zero air calibration cylinder to introduce "fresh air" to the sample draw adapter and verify an accurate zero setting.*

1. Verify that the sample-draw detector is sampling a fresh air environment (environment known to be free of combustible gas, H₂S, or CO and of normal oxygen content, 20.9%).
2. Open the housing door.
3. Set a voltmeter to measure in the millivolt (mV) range.
4. Check the zero reading for each channel.
 - For the LEL channel, plug the voltmeter leads into the test points on the LEL transmitter. Plug the positive lead into the test point labeled TP+; plug the negative lead into the test point labeled TP-.
 - For the oxygen channel, plug the voltmeter into the test points on the oxygen transmitter. Plug the positive lead into the test point labeled TP+; plug the negative lead into the test point labeled TP-.
 - For the CO channel, plug the voltmeter into the test points in the AMP 1 section of the main circuit board. Plug the positive lead into the test point labeled CAL+1; plug the negative lead into the test point labeled CAL-1.
 - For the H₂S channel, plug the voltmeter into the test points in the AMP 2 section

of the main circuit board. Plug the positive lead into the test point labeled CAL+2; plug the negative lead into the test point labeled CAL-2.

5. Verify a voltmeter reading of 100 mV (± 2 mV).
6. If necessary, use a small flat-blade screwdriver to adjust the zero pot until the voltmeter reading is 100 mV (± 2 mV).
7. Close the housing door.

Operation

Normal Operation

During normal operation, the Pilot LED will be on and the flowmeter will indicate about 1.2 SCFH. The current gas readings will be indicated at the controller. See the controller's operator's manual for a description of the reading indications.

Low Flow Alarm

If the flowrate falls below 0.6 SCFH (± 0.2 SCFH), then the sample draw detector will initiate a low flow alarm. In a low flow alarm the Fail LED will turn on and the pump will shut off. In addition, the CO and H₂S sensor signals to the controller will be interrupted by the sample draw detector resulting in a failure indication for the CO and H₂S channels at the controller. If a low flow alarm occurs, press the pump reset switch for about 2 seconds to restart the pump, turn off the Fail LED, and resume proper sensor signal transmission to the controller. If the condition continues, find the cause of the reduced flow, correct it, and restart the pump with the pump reset switch. A flow reduction can be caused by a flow blockage, a leak in the flow system, a malfunctioning pressure switch, or a malfunctioning pump.

NOTE: There is no flow fail indication for the LEL and oxygen channels on the 35-3010RKA-01.

Maintenance

This section describes maintenance procedures. It includes preventive maintenance procedures. This section also includes procedures to troubleshoot the sample-draw detector, replace components of the sample-draw detector, and adjust the low flow setting.

Preventive Maintenance

This section describes a preventive maintenance schedule to ensure the optimum performance of the sample-draw detector. It includes daily, monthly, and quarterly procedures.

Daily

1. Verify that the pilot light is on.
2. Verify that the flowmeter indicates a flow rate of approximately 1.2 SCFH. If necessary use the bypass valve or flow adjust potentiometer to adjust the flow rate to 1.2 SCFH.
3. Verify a reading of 0%LEL for the combustible channel (100 mV at the LEL transmitter test points), 20.9% for the oxygen channel (434 mV at the oxygen transmitter test

points), 0 ppm for the CO channel (100 mV at the amp 1 test points), and 0 ppm for the H₂S channel (100 mV at the amp 2 test points). Investigate significant changes in the reading.

Monthly

This procedure describes a test to verify that the sample-draw detector responds properly to the target gases.

Preparing for the response test

CAUTION: *This procedure may cause alarms at the monitoring device. Take appropriate action to avoid this, such as entering the calibration mode at the monitoring device.*

1. Verify that the controller is reading 0 for the combustible, CO, and H₂S channels and 20.9 for the oxygen channel.

If the reading is not 0 on the combustible, CO, or H₂S channels or 20.9 on the oxygen channel, set the zero reading as described in “Start Up” on page 14, then continue this procedure.

2. Assemble the calibration kit as described in the Calibration section of this manual. Use of a 4-gas cylinder is recommended so that all channels may be checked at once.

Performing the response test

NOTE: This procedure describes the RKI calibration kit that includes a demand flow regulator.

1. Screw the regulator into the calibration cylinder.
2. Connect the calibration tubing from the regulator to the inlet line at or near the INLET fitting. Gas will begin to flow.
3. After approximately one minute, verify that the reading for each channel at the controller stabilizes within $\pm 10\%$ of the concentration of the test sample. If the reading is not within $\pm 10\%$ of the test sample, calibrate the sample-draw detector as described in the Calibration section of this manual.
4. Remove the calibration tubing from the inlet line, then reconnect the inlet line.

Quarterly

Calibrate the sample-draw detector as described in the “Calibration” section on page 14.

Troubleshooting

The troubleshooting guide describes symptoms, probable causes, and recommended action for problems you may encounter with the sample-draw gas detector.

NOTE: This troubleshooting guide describes sample-draw detector problems only. See the instruction manual for the monitoring device if it exhibits any problems.

Fail Condition

Symptoms

- The sample-draw detector’s Fail light is on.
- The controller is operating properly but indicates a reading well below zero on one or

more channels.

Probable Causes

- The sample-draw detector's flow rate is too low because of an obstructed sample line, failed pump, etc.
- The sample-draw detector is malfunctioning.
- The sensor or transmitter wiring is disconnected or misconnected.

Recommended Action

1. At the sample-draw detector, set the correct flow rate with the bypass valve or flow adjust potentiometer.
2. If you cannot set the correct flow rate, check the sample lines for obstructions or kinks.
3. Verify that the sensor and transmitter wiring are correct and secure. "Installation" on page 10 describes detector wiring connections.
4. Calibrate the problem channel or channels as described in the Calibration section.
5. If the fail condition continues, replace the sensor from the problem channel or channels as described later in this section.
6. If the fail condition continues, contact RKI Instruments, Inc. for further instruction.

Slow or No Response/Difficult or Unable to Calibrate

Symptoms

- One or more of the sensors respond slowly or does not respond during the monthly response test.
- Unable to accurately set the zero or response reading on one or more of the channels during the calibration procedure.
- One or more of the sensors requires frequent calibration.

NOTE: Under "normal" circumstances, the sample-draw detector requires calibration once a quarter. Some applications may require a more frequent calibration schedule.

Probable Causes

- The calibration cylinder is low, out-dated, or defective.
- The sample-draw detector's flow rate is too low because of an obstructed sample line, failed pump, etc.
- The sample-draw detector is malfunctioning.

Recommended Action

1. Verify that the calibration cylinder contains an adequate supply of a fresh test sample.
2. If necessary, set the correct flow rate with the bypass valve or flow adjust potentiometer.
3. If you cannot set the correct flow rate, check the sample line for obstructions or kinks.
4. If the calibration/response difficulties continue, replace the sensor as described later in this section.
5. If the calibration/response difficulties continue, contact RKI Instruments, Inc. for further instruction.

Replacing Components of the Sample-Draw Detector

This section includes procedures to replace the sensors, the hydrophobic filter, and the charcoal filter.

Replacing the Combustible Sensor

1. Turn off incoming power.
2. Open the housing door of the sample-draw detector.
3. Unscrew and remove the two screws that secure the retaining plate, then lift the plate, connector, and sensor out of the housing.
4. Unplug the connector from the sensor.
5. Verify that you are using the correct replacement sensor (NC-6245 is printed on the sensor), then plug the sensor into the connector.
6. Place the sensor in the combustible gas sensor cavity, then position the retaining plate on the two standoffs.
7. Secure the retaining plate to the standoffs with the two screws you removed in step 3.
8. Turn on incoming power.
9. Calibrate the replacement sensor as described in “Calibration, LEL Detector” on page 20.

Replacing the Oxygen Sensor

1. Turn off incoming power.
2. Open the housing door of the sample-draw detector.
3. Unscrew and remove the two screws that secure the retaining plate, then lift the plate, connector, and sensor out of the housing.
4. Unplug the connector from the socket that leads from the sensor.
5. Plug the socket of the replacement sensor into the connector.
6. Place the sensor in the oxygen sensor cavity, then position the retaining plate on the two standoffs.
7. Secure the retaining plate to the standoffs with the two screws you removed in step 3.
8. Turn on incoming power.
9. Calibrate the replacement sensor as described in “Calibration, Oxygen Detector” on page 22.

Replacing the Carbon Monoxide Sensor

1. Turn off incoming power.
2. Open the housing door of the sample-draw detector.
3. Unscrew the 5 screws that retain the preamp circuit board.
4. Lift the preamp circuit board away from the flow block.
Be careful not to pull on the cables that connect the preamp circuit to the main circuit board.
There is a foam gasket in the bottom of each flow cavity beneath the circuit board. Make sure the gaskets stay in place.
5. Pull the CO sensor off the preamp circuit board. It is located in the amp 1 position (left side) of the preamp circuit board.
6. Plug the new sensor into the preamp board.

7. Reinstall the preamp circuit board with the sensors onto the flow block.
8. Turn on incoming power.
9. Calibrate the replacement sensor as described in “Calibration, H₂S and CO Detectors” on page 23.

Replacing the Hydrogen Sulfide Sensor

1. Turn off incoming power.
2. Open the housing door of the sample-draw detector.
3. Unscrew the 5 screws that retain the preamp circuit board.
4. Lift the preamp circuit board away from the flow block.

Be careful not to pull on the cables that connect the preamp circuit to the main circuit board.

There is a foam gasket in the bottom of each flow cavity beneath the circuit board. Make sure the gaskets stay in place.

5. Pull the H₂S sensor off the preamp circuit board. It is located in the amp 2 position (right side) of the preamp circuit board.
6. Plug the new sensor into the preamp board.
7. Reinstall the preamp circuit board with the sensors onto the flow block.
8. Turn on incoming power.
9. Calibrate the replacement sensor as described in “Calibration, H₂S and CO Detectors” on page 23.

Replacing the Hydrophobic Filter

1. Turn off or unplug power to the controller.
2. Locate the hydrophobic filter. It is just to the left of the main circuit board.
3. Grasp the hydrophobic filter and pull it out of its metal clamp.
4. Remove the rubber seals from each end of the hydrophobic filter and remove the filter.
5. Place the new hydrophobic filter in the same orientation as the one that was removed.
6. Place the new hydrophobic filter back into the metal clamp.

Replacing the Charcoal Filter

1. Turn off or unplug power to the controller.
2. Locate the charcoal filter. It is located along the upper edge of the detector housing.
3. Grasp the charcoal filter and pull it out of its metal clamp.
4. Remove the rubber seals from each end of the charcoal filter and remove the filter.
5. Place the new charcoal filter in the same orientation as the one that was removed.
6. Place the new charcoal filter back into the metal clamp.

Adjusting the Low Flow Setting

The factory-set low flow setting is 0.6 SCFH (± 0.2). To adjust the low flow setting:

1. Use the flow adjust potentiometer (VR1) to set the flow to 0.6 SCFH.

If the sample-draw detector goes into low flow alarm before you can adjust the flow down to 0.6 SCFH, adjust the low flow potentiometer 1/4 turn clockwise, then

attempt to set the flow again. Repeat this step until you are able to adjust the flow to 0.6 SCFH.

2. Slowly turn the low flow potentiometer counterclockwise just until the sample-draw detector goes into low flow alarm.

NOTE: The low flow potentiometer is accessible through a circular cutout in the main circuit board. The cutout is labeled PS1.

3. Verify that the low flow alarm is 0.6 SCFH (± 0.2). Repeat steps 3 and 4 if necessary.
4. Use the flow adjust potentiometer (VR1) to set the flow to 1.2 SCFH.
5. Make sure the sample-draw detector's Fail light is off.

Calibration Frequency

Although there is no particular calibration frequency that is correct for all applications, a calibration frequency of every 3 months is adequate for most sample draw detector applications. Unless experience in a particular application dictates otherwise, RKI Instruments, Inc. recommends a calibration frequency of every 3 months for the sample draw detector.

If an application is not very demanding, for example detection in a clean, temperature controlled environment, and calibration adjustments are minimal at calibration, then a calibration frequency of every 6 months is adequate for the sample draw detector.

If the application is very demanding, for example if the environment is not well controlled, then more frequent calibration than every 3 months may be necessary for the sample draw detector.

Calibration, LEL Detector

This section describes how to calibrate the LEL sensor in the sample draw detector. It includes procedures to prepare for calibration, set the zero reading, set the response reading, and return to normal operation.

NOTE: This procedure describes calibration using a demand flow regulator, a zero air calibration cylinder, and a 4-gas calibration cylinder.

Preparing for Calibration

CAUTION: *This procedure may cause alarms at the controller. Take appropriate action to avoid this, such as entering the calibration mode at the controller.*

1. Open the housing door.
2. Set a voltmeter to measure in the millivolt (mV) range.
3. Plug the voltmeter into the test points on the LEL transmitter. Plug the positive lead into the test point labeled TP+; plug the negative lead into the test point labeled TP-.

4. Use the following formula to determine the correct test points output for the calibrating sample.

$$\text{Output (mV)} = (\text{calibrating sample/fullscale}) \times 400 + 100$$

For example, with a calibrating sample of 50 %LEL methane and a fullscale setting of 100%LEL, the correct output for the LEL test points is 300 mV.

$$300 \text{ (mV)} = (50/100) \times 400 + 100$$

Setting the Zero Reading

NOTE: If you can verify a fresh air environment, it is not necessary to use the zero air calibration cylinder to set the zero reading.

1. Screw the regulator into the zero air calibration cylinder.
2. Connect the calibration kit sample tubing to the regulator.
3. Connect the sample tubing from the regulator to the inlet line at or near the INLET fitting.
4. Allow the gas to flow for one minute.
5. Verify a voltmeter reading of $100 \text{ mV} \pm 2 \text{ mV}$ at the test points as described in the Preparing for Calibration section above.
6. If necessary, use a small flat-blade screwdriver to adjust the zero pot until the voltmeter reading is $100 \text{ mV} \pm 2 \text{ mV}$.
7. Disconnect the sample tubing from the inlet line.
8. Unscrew the regulator from the zero air calibration cylinder. Leave the sample tubing connected to the regulator.

Setting the Response Reading

1. Screw the regulator into the 4-gas calibration cylinder.
2. Connect the sample tubing from the regulator to the inlet line at or near the sample-draw detector's INLET fitting.
3. Allow the calibration gas to flow for one minute.
4. Check the mV output on the LEL transmitter test points and verify that the reading matches the response reading ($\pm 2 \text{ mV}$) you determined earlier.
5. If necessary, use the span pot on the LEL transmitter to adjust the reading to match the correct response reading.
6. Disconnect the sample tubing from the sample-draw detector's inlet line.
7. Unscrew the regulator from the calibration cylinder.

NOTE: For convenience, leave the regulator connected to the sample tubing.

Returning to Normal Operation

1. Remove the voltmeter leads from the test points.
2. Reconnect the incoming sample line.
3. Wait 1 to 2 minutes to allow the calibration gas to be drawn out and the reading to stabilize.
4. Close the housing door.

5. Store the components of the calibration kit in a safe and convenient place.

Calibration, Oxygen Detector

This section describes how to calibrate the oxygen detector in the sample-draw detector. It includes procedures to prepare for calibration, set the zero reading, set the fresh air reading, and return to normal operation.

NOTE: This procedure describes calibration using a demand flow regulator, a zero air calibration cylinder, and a 4-gas calibration cylinder to set the zero reading. A 4-gas cylinder is used to set the zero since it is already used to calibrate the LEL, CO, and H₂S channels. A 100% nitrogen calibration cylinder could also be used to set the zero reading.

Preparing for Calibration

CAUTION: *This procedure may cause alarms at the controller. Take appropriate action to avoid this, such as entering the calibration mode at the controller.*

1. Open the housing door.
2. Set a voltmeter to measure in the millivolt (mV) range.
3. For the oxygen channel, plug the voltmeter into the test points on the oxygen transmitter. Plug the positive lead into the test point labeled **TP+**; plug the negative lead into the test point labeled **TP-**.
4. Use the following formula to determine the correct test points output for the calibrating sample.

$$\text{Output (mV)} = (\text{calibrating sample/fullscale}) \times 400 + 100$$

For example, with a calibrating sample of 12% and a fullscale setting of 25%, the correct output for the oxygen test points is 292 mV.

$$292 \text{ (mV)} = (12/25) \times 400 + 100$$

Setting the Zero Reading

NOTE: The 4-gas calibration cylinder included in the calibration kit may be used to zero the oxygen channel. Keep in mind that the oxygen concentration in that cylinder is 12%, not 0%. Be sure to set the controller appropriately.

1. Screw the regulator into the 4-gas calibration cylinder.
2. Connect the calibration kit sample tubing to the regulator.
3. Allow the sample-draw detector to respond to the calibrating sample for approximately 1 minute.
4. After one minute, check the mV output on the oxygen transmitter test points and verify that the reading matches the response reading (± 2 mV) you determined earlier (292 mV for 12% oxygen).
5. If necessary, use the span pot on the transmitter to adjust the reading to match the correct response reading.
6. Disconnect the sample tubing from the inlet line.

7. Unscrew the regulator from the 4-gas calibration cylinder.
8. For convenience, leave the regulator attached to the sample tubing.

Setting the Fresh Air Reading

CAUTION: *This procedure may cause alarms at the controller. Take appropriate action to avoid this, such as entering the calibration mode at the controller.*

NOTE: If you can verify a fresh air environment, it is not necessary to use the zero air calibration cylinder to set the zero reading.

1. Screw the regulator into the zero air calibration cylinder.
2. Connect the calibration kit sample tubing to the regulator.
3. Connect the sample tubing from the regulator to the inlet line at or near the INLET fitting.
4. Allow the gas to flow for one minute.
5. Verify a voltmeter reading of $434 \text{ mV} \pm 2 \text{ mV}$ at the test points as described in the Preparing for Calibration section above.
6. If necessary, use a small flat-blade screwdriver to adjust the zero pot until the voltmeter reading is $434 \text{ mV} \pm 2 \text{ mV}$.
7. Disconnect the sample tubing from the inlet line.
8. Unscrew the regulator from the zero air calibration cylinder. Leave the sample tubing connected to the regulator.

Returning to Normal Operation

1. Reconnect the incoming sample line.
2. Wait 1 to 2 minutes to allow the calibration gas to be drawn out and the reading to stabilize.
3. Close the housing door.
4. Store the components of the calibration kit in a safe and convenient place.

Calibration, H₂S and CO Detectors

This section describes how to calibrate the H₂S and CO detectors in the sample-draw detector. It includes procedures to prepare for calibration, set the zero reading for each channel, set the response reading for each channel, and return to normal operation.

NOTE: This procedure describes calibration using a demand flow regulator, a zero air calibration cylinder, and a 4-gas calibration cylinder.

Preparing for Calibration

CAUTION: *This procedure may cause alarms at the controller. Take appropriate action to avoid this, such as entering the calibration mode at the controller.*

1. Open the housing door.
2. Set a voltmeter to measure in the millivolt (mV) range. It will be used in the calibration of the CO and H₂S channels.
 - When checking the mV output of the CO channel, plug the voltmeter leads into the test points in the AMP 1 section of the main circuit board. Plug the positive lead into the test point labeled **CAL+1**; plug the negative lead into the test point labeled **CAL-1**.
 - When checking the mV output of the H₂S channel, plug the voltmeter leads into the test points in the AMP 2 section of the main circuit board. Plug the positive lead into the test point labeled **CAL+2**; plug the negative lead into the test point labeled **CAL-2**.
3. Use the following formula to determine the correct test points output for the CO and H₂S calibrating sample.

$$\text{Output (mV)} = (\text{calibrating sample/fullscale}) \times 400 + 100$$

For example, with a calibrating sample of 25 ppm H₂S and a fullscale setting of 100 ppm H₂S, the correct output for the H₂S test points is 200 mV.

$$200 \text{ (mV)} = (25/100) \times 400 + 100$$

Setting the Zero Reading

1. Screw the regulator into the zero air cylinder.
2. Connect the calibration kit sample tubing to the regulator.
3. Connect the sample tubing from the regulator to the inlet line at or near the INLET fitting.
4. Allow the gas to flow for 1 minute.
5. Verify a voltmeter reading of 100 mV ± 2 mV at the AMP 1 and AMP 2 test points for the CO and H₂S channels as described in the Preparing for Calibration section above.
6. If necessary, use a small flat-blade screwdriver to adjust the zero pot for the CO or H₂S channel until the voltmeter reading is 100 mV ± 2 mV.
7. Disconnect the sample tubing from the inlet line.
8. Unscrew the regulator from the zero air cylinder. Leave the sample tubing connected to the regulator.

Setting the Response (Span) Reading

1. Screw the regulator into the 4-gas calibration cylinder.
2. Connect the sample tubing from the regulator to the inlet line at or near the sample draw detector's INLET fitting.
3. Allow the calibration gas to flow for 1 minute.
4. Check the mV output on the AMP 1 test points for CO and verify that the reading matches the response reading (±2 mV) you determined earlier.
5. If necessary, use the AMP 1 span pot to adjust the reading to match the correct response reading.
6. Check the mV output on the AMP 2 test points for H₂S and verify that the reading matches the response reading (±2 mV) you determined earlier.
7. If necessary, use the AMP 2 span pot to adjust the reading to match the correct

response reading.

8. Disconnect the sample tubing from the sample draw detector's inlet line.
9. Unscrew the regulator from the calibration cylinder.

NOTE: For convenience, leave the regulator connected to the sample tubing.

Returning to Normal Operation

1. Remove the voltmeter leads from the test points.
2. Reconnect the incoming sample line.
3. Wait 1 to 2 minutes to allow the calibration gas to be drawn out and the readings to stabilize.
4. Close the housing door.
5. Store the components of the calibration kit in a safe and convenient place.

Parts List

Table 4 lists replacement parts and accessories for the sample-draw gas detector.

Table 2: Parts List

Part Number	Description
06-1248RK	Sample tubing, 3/16 x 5/16, specify length, (for calibration kit)
07-0034RK	Sealing gasket, for CO and H ₂ S flow block cavities
30-0610RK	Pump
33-0171RK	Hydrophobic filter (AcroPak)
33-6095RK	Charcoal filter, CF-188
65-0601RK	Oxygen sensor
81-0076RK-01	Zero air calibration cylinder (34 liter)
81-0154RK-04	4-gas calibration gas cylinder, 50% LEL methane/12% oxygen/25 ppm H ₂ S/50 ppm CO, 34 liter
81-1055RK	Regulator, demand flow, for 17 and 34 liter steel cylinders
ES-1531-CO	CO sensor
ES-1537-H2S	H ₂ S sensor
NC-6245	Combustible sensor